

Motorized linear stage

Instruction Manual



Model number : KXL06□□□-□□-□□□

KZL06□□□-□□-□□□

Please use and operate only after ensuring a firm understanding of the instruction manual.
Failure to observe this may result in personal injury and/or property damage!



IMPORTANT – The 'colour inside' logo on the cover page of this publication indicates that it contains colours which are considered to be useful for the correct understanding of its content. Users should therefore print this document using a colour printer.

This manual does not cover all KXL06 and KZL06 series models.

Please use the product after ensuring an understanding of the content.

Contents

1.	Introduction	3
1.1	Before Using This Product	3
1.2	Safety Precautions	4
1.3	General Product Warnings and Precautions	5
2.	Overview	7
2.1	Model configuration	7
2.2	Attached screw	10
2.3	Name of Each Part	11
2.4	Description of Labels	13
2.5	Specifications	14
2.6	Timing chart	25
2.7	Product Dimensions	30
2.8	Connection	50
2.9	Operating Environment	56
2.10	Mounting Guidelines	57
3.	Compliance with EU Directives	60
3.1	Low Voltage Directive	60
3.2	EMC Directive	60
3.3	RoHS Directive	60
3.4	Compliance with EMC Directive	61
4.	Maintenance and Inspection	61
4.1	Inspection	63
4.2	Maintenance	64
4.3	Storage and Transport	65
4.4	Disposal Method	66
5.	Warranty Scope, Warranty Period	67
■	Contact Information	69

1. Introduction

1.1 Before Using This Product

Thank you for purchasing this product.

- ※ This manual contains such information as the required functionality, performance, and usage method and so on for use of this product.

Please read this manual carefully beforehand in order to ensure correct use of the product.

Always store this manual in a readily accessible location after reading.

- ※ Please contact SURUGA SEIKI Co., Ltd. if this manual is lost or damaged.

This product is a highly rigid, high-accuracy precision positioning stage. This machine is intended for use based on the prerequisite that it is integrated into equipment. Refer to the information on residual risk in this manual for details on residual risk. When using this product integrated into equipment, always conduct a risk evaluation, and verify and implement risk reduction measures for the equipment as a whole to ensure safe use.

This product should only be handled by those who have read this manual carefully and fully understand its content. Please read the "Safety Precautions" carefully beforehand in order to ensure correct use. Please understand that SURUGA SEIKI accepts no responsibility for compensation for damages incurred as a result of failure to heed this warning.

1.2 Safety Precautions

The precautions indicated here are intended to ensure safe and correct use of the product, and to prevent harm or injury to customers or others before it happens. Always read these safety precautions carefully and ensure an understanding of the content before use.



Indicates a potential hazard with high level of risk which, if not avoided, will result in death or serious injury.



Indicates a potential hazard with medium level of risk which, if not avoided, could result in death or serious injury.



Indicates a potential hazard with low level of risk which, if not avoided, could result in minor or moderate injury.

The safety precautions indicated in this instruction manual refer to the following standards.
ISO 12100:2010



Indicates "prohibited" content.



Indicates "compulsory" content.

1.3 General Product Warnings and Precautions

Warning symbols on devices are equivalent to the warnings indicated in the relevant manuals.



WARNING



This product should only be handled by those who have read this manual carefully and fully understand its content. Failure to use the product correctly may result in injury or a fault.



WARNING



The use of this product in the medical equipment, pharmaceutical, biological, food, or cosmetic fields is prohibited.



WARNING



The use of this product for aerospace instruments, nuclear plant components, weapons, arms, or other military applications is prohibited.



WARNING



Never disassemble, modify, or carry out unwarranted repairs on this product. Failure to observe this may result in an unexpected accident.



WARNING



Do not place fingers or objects in the opening of the product. Failure to observe this may result in injury or a fault.



WARNING



Do not transport the product or carry out mounting work with an unnatural posture. Failure to observe this may result in injury or a fault.

 **WARNING**



Users must not touch the product during operation. Furthermore, ensure that the product is not touched by anyone other than users. Failure to observe this may result in injury.

 **WARNING**



In the following cases, stop use of the product immediately and notify SURUGA SEIKI Co., Ltd. Continued use of the product may result in injury or a fault.

- If the product emits an abnormal noise
- If the product exhibits abnormalities such as an abnormal odour or smoke
- If the product suffers damage after being dropped
- If the cable is damaged or torn
- If liquid is spilled on, or foreign material gets inside the product
- If there is any play in component parts such as the table or cover

 **WARNING**



If any abnormalities are confirmed, cut the supply of power to the DC power supply immediately. After doing so, disconnect the stage cable from the stage.

 **CAUTION**



Do not forcibly bend, pull, or trap the cable. Failure to observe this may result in damage to the cable.

 **CAUTION**



Use the cable, driver, and DC power supply specified by SURUGA SEIKI. Use of other than those specified is not covered by warranty.

2. Overview

This product is a positioning stage driven by a stepping motor.

Positions at desired locations are determined by moving the table in the linear direction with a ball screw.

The product is mainly used for the purpose of making fine position adjustments.

2.1 Model configuration

This section explains the model configuration of this product.

Type with 30 to 75 mm stroke

K X L 0 6 □ □ □ - □ □ - □ □ □
 ① ② ③ ④ ⑤ ⑥ ⑦

No.	Contents	Description
①	Model number	KXL06
②	Stroke	030 : 30mm 050 : 50mm 075 : 75mm
③	Cover select	N : Without cover C : With cover
④	Lead select	1 : Lead 1mm 2 : Lead 2mm
⑤	Motor option	C : Standard (C005C-90215P-1) F : High Torque (PK525HPB-C1) G : High Resolution (PK523HPMB-C1)
⑥	Origin sensor option	No symbol: Without origin sensor option 1 : CCW right side 2 : CCW left side 3 : Center right side 4 : Center left side 5 : CW right side 6 : CW left side
⑦	Cable option	B: Standard cables: Connector free on one end, 2 m (D214-2-2EK) D: Standard cables: Connector free on one end, 4m (D214-2-4EK) G: Robot cables: Connector free on one end, 2m (D214-2-2RK) J: Robot cables: Connector free on one end, 4m (D214-2-4RK) No symbol: Without cable

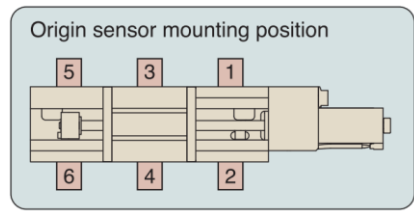

Type with 100 to 300 mm stroke

K X L 0 6 □ □ □ - □ □ - □ □ □
 ① ② ③ ④ ⑤ ⑥ ⑦

No.	Contents	Description
①	Model number	KXL06
②	Stroke	100 : 100mm 150 : 150mm 200 : 200mm 300 : 300mm
③	Cover select	N : Without cover C : With cover
④	Lead select	2 : Lead 2mm
⑤	Motor option	F : High Torque (PK525HPB-C1) G : High Resolution (PK523HPMB-C1)
⑥	Origin sensor option	No symbol: Without origin sensor option 1 : CCW right side 2 : CCW left side 3 : Center right side 4 : Center left side 5 : CW right side 6 : CW left side
⑦	Cable option	B: Standard cables: Connector free on one end, 2 m (D214-2-2EK) D: Standard cables: Connector free on one end, 4m (D214-2-4EK) G: Robot cables: Connector free on one end, 2m (D214-2-2RK) J: Robot cables: Connector free on one end, 4m (D214-2-4RK) No symbol: Without cable

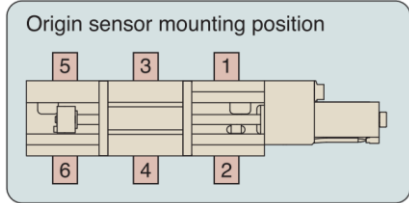

Type with KXL06 attached to dedicated bracket

K Z L 0 6 □ □ □ - □ □ - □ □ □
 ① ② ③ ④ ⑤ ⑥ ⑦

No.	Contents	Description
①	Model number	KZL06
②	Stroke	030 : 30mm 050 : 50mm 075 : 75mm
③	Cover select	N : Without cover C : With cover
④	Lead select	1 : Lead 1mm
⑤	Motor option	C : Standard (C005C-90215P-1) F : High Torque (PK525HPB-C1) G : High Resolution (PK523HPMB-C1)
⑥	Origin sensor option	No symbol: Without origin sensor option 1 : CCW right side 2 : CCW left side 3 : Center right side 4 : Center left side 5 : CW right side 6 : CW left side
⑦	Cable option	B: Standard cables: Connector free on one end, 2 m (D214-2-2EK) D: Standard cables: Connector free on one end, 4m (D214-2-4EK) G: Robot cables: Connector free on one end, 2m (D214-2-2RK) J: Robot cables: Connector free on one end, 4m (D214-2-4RK) No symbol: Without cable

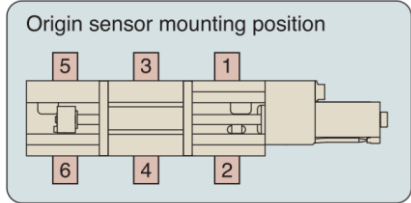

2.2 Attached screw

Standard hexagon socket head cap screws for mounting have been provided.

KXL06030/050/075/100

Attached screws: M4x14 hexagon socket head cap bolts: 8

KXL06150

Attached screws: M4x14 hexagon socket head cap bolts: 14

KXL06200

Attached screws: M4x14 hexagon socket head cap bolts: 12

KXL06300

Attached screws: M4x14 hexagon socket head cap bolts: 16

KZL06030/050/075

Attached screws: M4x10 hexagon socket head cap bolts: 4

2.3 Name of Each Part

The names of each product part are as follows.

KXL06 without cover

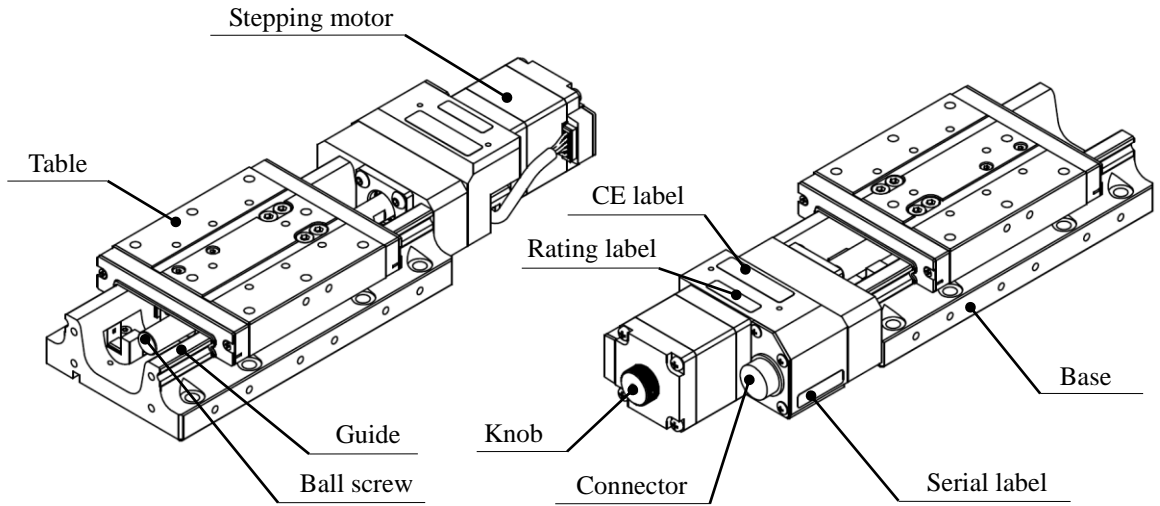

KXL06 with cover

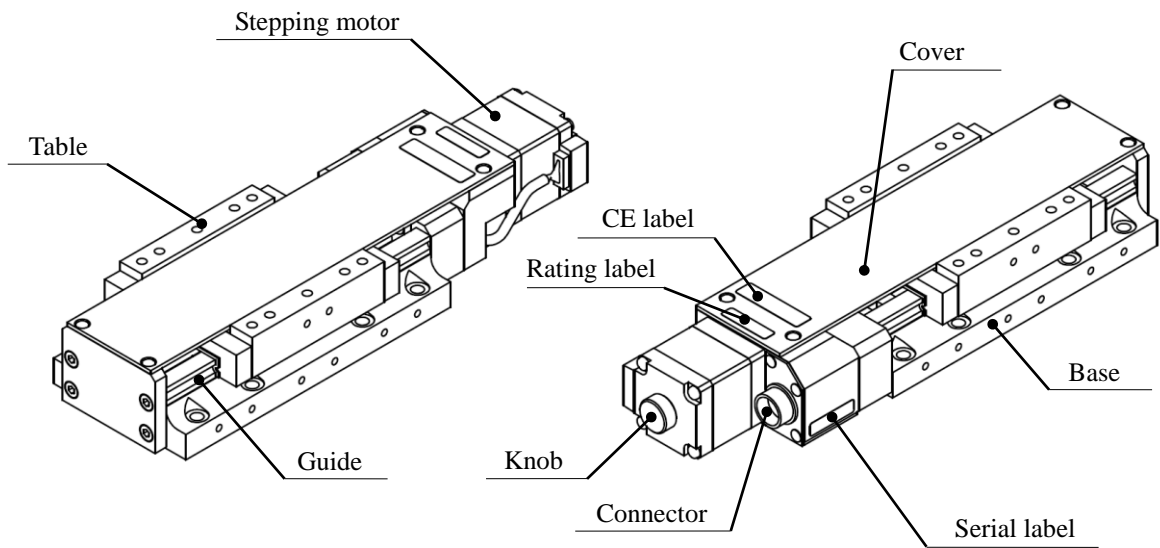

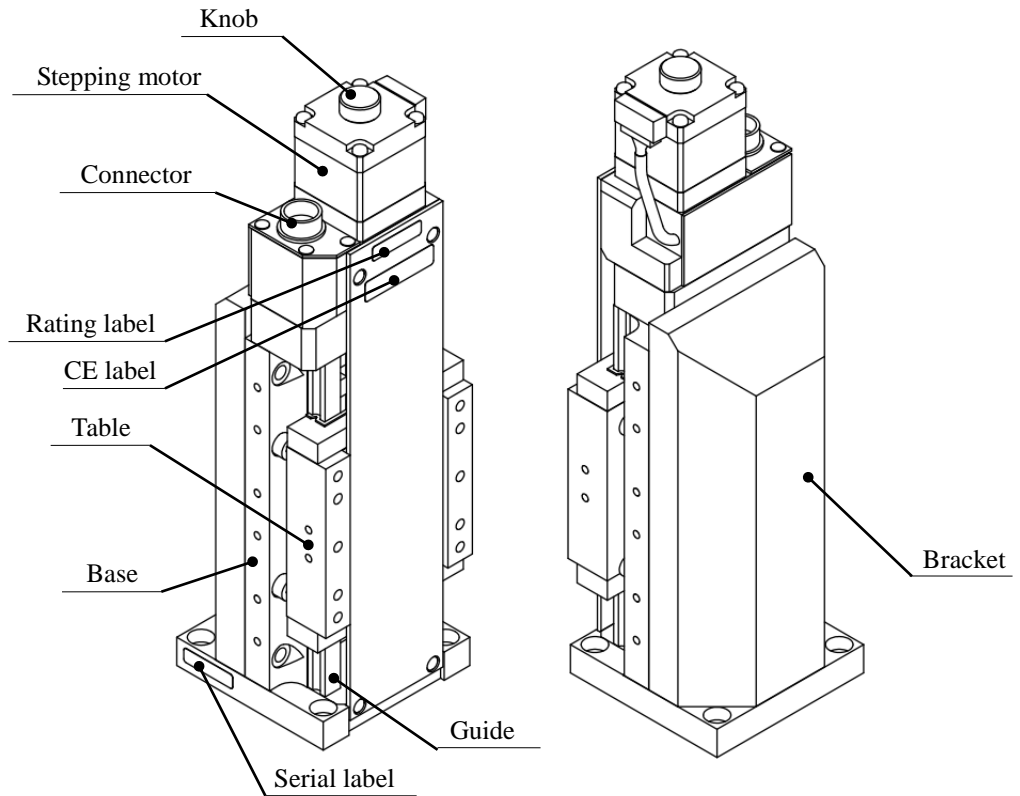

In order to avoid injury and damage if the product drops, always carry the product by holding the base.



The knob is set to high-speed rotation when driving, and should therefore not be touched.

2.4 Description of Labels

The content of product labels is described below.

CE labels



Serial label



Rating label



*There is a case where other labels are affixed to places other than the labels described in this manual. Please do not peel off because these are labels for internal management.

The content of product labels on the packing box is described below.



Indicates that the box should be handled with care to prevent applying any impact.



Indicates that care should be taken when handling the packing box as the product is fragile.



Indicates that the box should be protected when handling to prevent it from getting wet.



Indicates that the box should not be turned upside down or stacked horizontally.



Indicates that corrugated cardboard can be recycled.



Indicates that the packaging material can be recycled, and that the material is corrugated cardboard.

2.5 Specifications

■ Main specification

Model number		KXL06030-N1-C	KXL06030-N1-F	KXL06030-N1-G
(Model number with cover)		KXL06030-C1-C	KXL06030-C1-F	KXL06030-C1-G
Ball screw		Φ8 lead 1mm		
Stroke (*1)		30 mm		
Table size		60 x 60 mm		
Guide		Linear ball guide		
Material (finishing)		Stainless steel (Electroless nickel plating)		
Load capacity		12 kgf 【117.6 N】		
Weight	Without cover	1.28 kg	1.37 kg	1.28 kg
	With cover	1.34 kg	1.43 kg	1.34 kg
Resolution (Pulse)	Full / Half	2 μm / 1 μm		1 μm / 0.5 μm
	Microstep	0.1 μm (MS 1/20)		0.05 μm (MS 1/20)
MAX speed		30 mm/s	35 mm/s	25 mm/s
Moment rigidity		Pitch 0.05 / Yaw 0.05 / Roll 0.05 ["/N·cm]		
Uni-directional positioning accuracy		≤ 5 μm		
Repeatability		≤ ±0.5 μm		
Lost motion		≤ 1 μm		
Backlash		≤ 1 μm		
Straightness		≤ 3 μm		
Parallelism		≤ 15 μm		
Parallelism of motion		≤ 10 μm		
Pitching/ Yawing		≤ 20" / ≤ 15"		
Electrical rating		DC24V±10% 1.5A		

Model number	KXL06030-N2-C	KXL06030-N2-F	KXL06030-N2-G	
(Model number with cover)	KXL06030-C2-C	KXL06030-C2-F	KXL06030-C2-G	
Ball screw	Φ8 lead 2mm			
Stroke (*1)	30 mm			
Table size	60 x 60 mm			
Guide	Linear ball guide			
Material (finishing)	Stainless steel (Electroless nickel plating)			
Load capacity	12 kgf 【117.6 N】			
Weight	Without cover	1.28 kg	1.37 kg	1.28 kg
	With cover	1.34 kg	1.43 kg	1.34 kg
Resolution (Pulse)	Full / Half	4 μm / 2 μm		2 μm / 1 μm
	Microstep	0.2 μm (MS 1/20)		0.1 μm (MS 1/20)
MAX speed	35 mm/s	45 mm/s	30 mm/s	
Moment rigidity	Pitch 0.05 / Yaw 0.05 / Roll 0.05 ["/N·cm]			
Uni-directional positioning accuracy	≤ 5 μm			
Repeatability	≤ ±0.5 μm			
Lost motion	≤ 1 μm			
Backlash	≤ 1 μm			
Straightness	≤ 3 μm			
Parallelism	≤ 15 μm			
Parallelism of motion	≤ 10 μm			
Pitching/ Yawing	≤ 20" / ≤ 15"			
Electrical rating	DC24V±10% 1.5A			

Model number	KXL06050-N1-C	KXL06050-N1-F	KXL06050-N1-G	
(Model number with cover)	KXL06050-C1-C	KXL06050-C1-F	KXL06050-C1-G	
Ball screw	Φ8 lead 1mm			
Stroke (*1)	50 mm			
Table size	60 x 60 mm			
Guide	Linear ball guide			
Material (finishing)	Stainless steel (Electroless nickel plating)			
Load capacity	12 kgf 【117.6 N】			
Weight	Without cover	1.40 kg	1.49 kg	1.40 kg
	With cover	1.44 kg	1.53 kg	1.44 kg
Resolution (Pulse)	Full / Half	2 μm / 1 μm		1 μm / 0.5 μm
	Microstep	0.1 μm (MS 1/20)		0.05 μm (MS 1/20)
MAX speed	30 mm/s	35 mm/s	25 mm/s	
Moment rigidity	Pitch 0.05 / Yaw 0.05 / Roll 0.05 ["/N·cm]			
Uni-directional positioning accuracy	≤ 5 μm			
Repeatability	≤ ±0.5 μm			
Lost motion	≤ 1 μm			
Backlash	≤ 1 μm			
Straightness	≤ 3 μm			
Parallelism	≤ 15 μm			
Parallelism of motion	≤ 10 μm			
Pitching/ Yawing	≤ 20"/≤ 15"			
Electrical rating	DC24V±10% 1.5A			

Model number	KXL06050-N2-C	KXL06050-N2-F	KXL06050-N2-G	
(Model number with cover)	KXL06050-C2-C	KXL06050-C2-F	KXL06050-C2-G	
Ball screw	Φ8 lead 2mm			
Stroke (*1)	50 mm			
Table size	60 x 60 mm			
Guide	Linear ball guide			
Material (finishing)	Stainless steel (Electroless nickel plating)			
Load capacity	12 kgf 【117.6 N】			
Weight	Without cover	1.40 kg	1.49 kg	1.40 kg
	With cover	1.44 kg	1.53 kg	1.44 kg
Resolution (Pulse)	Full / Half	4 μm / 2 μm		2 μm / 1 μm
	Microstep	0.2 μm (MS 1/20)		0.1 μm (MS 1/20)
MAX speed	35 mm/s	45 mm/s	30 mm/s	
Moment rigidity	Pitch 0.05 / Yaw 0.05 / Roll 0.05 ["/N·cm]			
Uni-directional positioning accuracy	≤ 5 μm			
Repeatability	≤ ±0.5 μm			
Lost motion	≤ 1 μm			
Backlash	≤ 1 μm			
Straightness	≤ 3 μm			
Parallelism	≤ 15 μm			
Parallelism of motion	≤ 10 μm			
Pitching/ Yawing	≤ 20"/≤ 15"			
Electrical rating	DC24V±10% 1.5A			

Model number	KXL06075-N1-C	KXL06075-N1-F	KXL06075-N1-G	
(Model number with cover)	KXL06075-C1-C	KXL06075-C1-F	KXL06075-C1-G	
Ball screw	Φ8 lead 1mm			
Stroke (*1)	75 mm			
Table size	60 x 60 mm			
Guide	Linear ball guide			
Material (finishing)	Stainless steel (Electroless nickel plating)			
Load capacity	12 kgf 【117.6 N】			
Weight	Without cover	1.54 kg	1.63 kg	1.54 kg
	With cover	1.60 kg	1.69 kg	1.60 kg
Resolution (Pulse)	Full / Half	2 μm / 1 μm		1 μm / 0.5 μm
	Microstep	0.1 μm (MS 1/20)		0.05 μm (MS 1/20)
MAX speed	30 mm/s	35 mm/s	25 mm/s	
Moment rigidity	Pitch 0.05 / Yaw 0.05 / Roll 0.05 ["/N·cm]			
Uni-directional positioning accuracy	≤ 7 μm			
Repeatability	≤ ±0.5 μm			
Lost motion	≤ 1 μm			
Backlash	≤ 1 μm			
Straightness	≤ 3 μm			
Parallelism	≤ 15 μm			
Parallelism of motion	≤ 10 μm			
Pitching/ Yawing	≤ 20"/≤ 15"			
Electrical rating	DC24V±10% 1.5A			

Model number	KXL06075-N2-C	KXL06075-N2-F	KXL06075-N2-G	
(Model number with cover)	KXL06075-C2-C	KXL06075-C2-F	KXL06075-C2-G	
Ball screw	Φ8 lead 2mm			
Stroke (*1)	75 mm			
Table size	60 x 60 mm			
Guide	Linear ball guide			
Material (finishing)	Stainless steel (Electroless nickel plating)			
Load capacity	12 kgf 【117.6 N】			
Weight	Without cover	1.54 kg	1.63 kg	1.54 kg
	With cover	1.60 kg	1.69 kg	1.60 kg
Resolution (Pulse)	Full / Half	4 μm / 2 μm		2 μm / 1 μm
	Microstep	0.2 μm (MS 1/20)		0.1 μm (MS 1/20)
MAX speed	35 mm/s	45 mm/s	30 mm/s	
Moment rigidity	Pitch 0.05 / Yaw 0.05 / Roll 0.05 ["/N·cm]			
Uni-directional positioning accuracy	≤ 7 μm			
Repeatability	≤ ±0.5 μm			
Lost motion	≤ 1 μm			
Backlash	≤ 1 μm			
Straightness	≤ 3 μm			
Parallelism	≤ 15 μm			
Parallelism of motion	≤ 10 μm			
Pitching/ Yawing	≤ 20" / ≤ 15"			
Electrical rating	DC24V±10% 1.5A			

Model number	KXL06100-N2-F	KXL06100-N2-G	KXL06150-N2-F	KXL06150-N2-G	
(Model number with cover)	KXL06100-C2-F	KXL06100-C2-G	KXL06150-C2-F	KXL06150-C2-G	
Ball screw	Φ8 lead 2mm				
Stroke (*1)	100 mm		150 mm		
Table size	60 x 60 mm				
Guide	Linear ball guide				
Material (finishing)	Stainless steel (Electroless nickel plating)				
Load capacity	12 kgf 【117.6 N】				
Weight	Without cover	1.80 kg	1.71 kg	2.10 kg	2.01 kg
	With cover	1.86 kg	1.77 kg	2.16 kg	2.07 kg
Resolution (Pulse)	Full / Half	4 μm / 2 μm	2 μm / 1 μm	4 μm / 2 μm	2 μm / 1 μm
	Microstep	0.2 μm (MS 1/20)	0.1 μm (MS 1/20)	0.2 μm (MS 1/20)	0.1 μm (MS 1/20)
MAX speed	45 mm/s	30 mm/s	45 mm/s	30 mm/s	
Moment rigidity	Pitch 0.05 / Yaw 0.05 / Roll 0.05 ["/N·cm]				
Uni-directional positioning accuracy	10 μm or less		15 μm or less		
Repeatability	≤ ±0.5 μm				
Lost motion	≤ 1 μm				
Backlash	≤ 1 μm				
Straightness	≤ 5 μm				
Parallelism	≤ 15 μm				
Parallelism of motion	≤ 10 μm		≤ 15 μm		
Pitching/ Yawing	≤ 25" / ≤ 20"				
Electrical rating	DC24V±10% 1.5A				

Model number	KXL06200-N2-F	KXL06200-N2-G	KXL06300-N2-F	KXL06300-N2-G	
(Model number with cover)	KXL06200-C2-F	KXL06200-C2-G	KXL06300-C2-F	KXL06300-C2-G	
Ball screw	Φ8 lead 2mm				
Stroke (*1)	200 mm		300 mm		
Table size	60 x 60 mm				
Guide	Linear ball guide				
Material (finishing)	Stainless steel (Electroless nickel plating)				
Load capacity	12 kgf 【117.6 N】				
Weight	Without cover	2.42 kg	2.33 kg	3.02 kg	2.93 kg
	With cover	2.48 kg	2.39 kg	3.12 kg	3.03 kg
Resolution (Pulse)	Full / Half	4 μm / 2 μm	2 μm / 1 μm	4 μm / 2 μm	2 μm / 1 μm
	Microstep	0.2 μm (MS 1/20)	0.1 μm (MS 1/20)	0.2 μm (MS 1/20)	0.1 μm (MS 1/20)
MAX speed	45 mm/s	30 mm/s	45 mm/s	30 mm/s	
Moment rigidity	Pitch 0.05 / Yaw 0.05 / Roll 0.05 ["/N·cm]				
Uni-directional positioning accuracy	≤ 15 μm		≤ 25 μm		
Repeatability	≤ ±0.5 μm				
Lost motion	≤ 1 μm				
Backlash	≤ 1 μm				
Straightness	≤ 7 μm				
Parallelism	≤ 15 μm				
Parallelism of motion	≤ 20 μm		≤ 25 μm		
Pitching/ Yawing	≤ 30"/ ≤ 20"		≤ 35"/ ≤ 20"		
Electrical rating	DC24V±10% 1.5A				

Model number	KZL06030-N1-C	KZL06030-N1-F	KZL06030-N1-G
(Model number with cover)	KZL06030-C1-C	KZL06030-C1-F	KZL06030-C1-G
Ball screw	Φ8 lead 1mm		
Stroke (*1)	30 mm		
Table size	60 x 60 mm		
Guide	Linear ball guide		
Material (finishing)	Stainless steel (Electroless nickel plating)		
Load capacity (When excited)	7 kgf 【68.6 N】		
Weight	Without cover	2.00 kg	2.09 kg
	With cover	2.06 kg	2.15 kg
Resolution (Pulse)	Full / Half	2 μm / 1 μm	
	Microstep	0.1 μm (MS 1/20)	
MAX speed	20 mm/s	30 mm/s	15 mm/s
Uni-directional positioning accuracy	≤ 5 μm *		
Repeatability	≤ ±0.5 μm *		
Lost motion	≤ 1 μm *		
Backlash	≤ 1 μm *		
Straightness	≤ 3 μm *		
Perpendicularity	≤ 15 μm / Full stroke		
Pitching/ Yawing	≤ 20" / ≤ 15" *		
Electrical rating	DC24V±10% 1.5A		

* When horizontal no load

Model number	KZL06050-N1-C	KZL06050-N1-F	KZL06050-N1-G
(Model number with cover)	KZL06050-C1-C	KZL06050-C1-F	KZL06050-C1-G
Ball screw	Φ8 lead 1mm		
Stroke (*1)	50 mm		
Table size	60 x 60 mm		
Guide	Linear ball guide		
Material (finishing)	Stainless steel (Electroless nickel plating)		
Load capacity (When excited)	7 kgf 【68.6 N】		
Weight	Without cover	2.12 kg	2.21 kg
	With cover	2.16 kg	2.25 kg
Resolution (Pulse)	Full / Half	2 μm / 1 μm	
	Microstep	0.1 μm (MS 1/20)	
MAX speed	20 mm/s	30 mm/s	15 mm/s
Uni-directional positioning accuracy	≤ 5 μm *		
Repeatability	≤ ±0.5 μm *		
Lost motion	≤ 1 μm *		
Backlash	≤ 1 μm *		
Straightness	≤ 3 μm *		
Perpendicularity	≤ 25 μm / Full stroke		
Pitching/ Yawing	≤ 20" / ≤ 15" *		
Electrical rating	DC24V±10% 1.5A		

* When horizontal no load

Model number	KZL06075-N1-C	KZL06075-N1-F	KZL06075-N1-G	
(Model number with cover)	KZL06075-C1-C	KZL06075-C1-F	KZL06075-C1-G	
Ball screw	Φ8 lead 1mm			
Stroke (*1)	75 mm			
Table size	60 x 60 mm			
Guide	Linear ball guide			
Material (finishing)	Stainless steel (Electroless nickel plating)			
Load capacity (When excited)	7 kgf 【68.6 N】			
Weight	Without cover	2.26 kg	2.35 kg	2.26 kg
	With cover	2.32 kg	2.41 kg	2.32 kg
Resolution (Pulse)	Full / Half	2 μm / 1 μm		1 μm / 0.5 μm
	Microstep	0.1 μm (MS 1/20)		0.05 μm (MS 1/20)
MAX speed	20 mm/s	30 mm/s	15 mm/s	
Uni-directional positioning accuracy	≤ 7 μm *			
Repeatability	≤ ±0.5 μm *			
Lost motion	≤ 1 μm *			
Backlash	≤ 1 μm *			
Straightness	≤ 3 μm *			
Perpendicularity	≤ 37.5 μm / Full stroke			
Pitching/ Yawing	≤ 20" / ≤ 15" *			
Electrical rating	DC24V±10% 1.5A			

* When horizontal no load

■ Each electric component specification

Motor	Code	C	F	G
	Model number	C005C-90215P-1	PK525HPB-C1	PK523HPMB-C1
	Type	5 phase stepping motor 0.75 A/phase (Oriental motor Co., Ltd.)		
	Step angle	0.72°		0.36°
Sensor	Limit sensor	Installed		
	Origin sensor(ORG)	— (Photomicro sensor PM-L25 when select the origin sensor)		
	Proximity origin sensor(NORG)	—		
	Model number	Photomicro sensor PM-L25 (Panasonic Industrial Devices SUNX Co., Ltd.)		
	Power voltage	DC5 - 24 V ±10%		
	Consumption current	45mA or less (15 mA or less per sensor)		
	Control output	NPN open collector output DC 30 V or less 50 mA or less Residual voltage 0.7 V or less (load current 50 mA) Residual voltage 0.4 V or less (load current 16 mA)		
	Out logic	When light is shielded: output transistor OFF(non-conduction)		
Connector	Model number	HR10A-10R-12P(73) (Hirose Electric Co., Ltd.)		
	Applicable receptacle connector	HR10A-10P-12S(73) (Hirose Electric Co., Ltd.)		

■ Noise level

- A-weighted Sound Pressure Level: This product does not emit the noise more than 70dB.

*1 Movement

Table movement indicates the full stroke.

If the movement is 30 mm, the table moves 15 mm in the + (CW) direction, and 15 mm in the – (CCW) direction, with the position shown in the traced drawing as the centre.

(*2)

*2 Definition of direction

The direction moving away from the motor is defined as the + (CW) direction, and the direction moving towards the motor is defined as the – (CCW) direction.

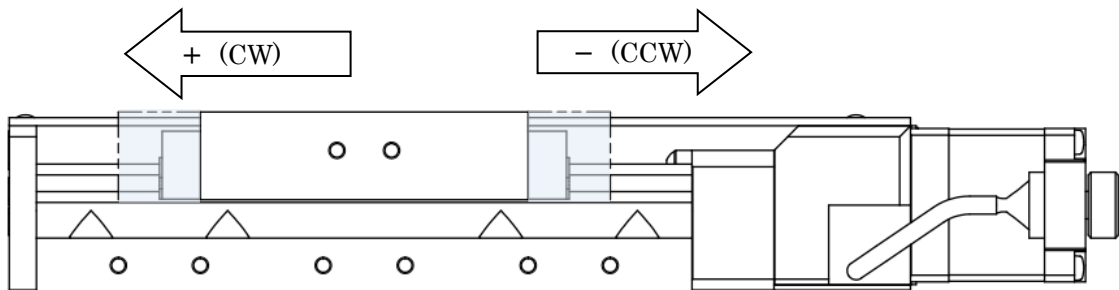

WARNING



Avoid using the product if the motor surface temperature reaches 80 °C or higher.

Failure to observe this may result in burns or a fault. The motor surface may still be hot, risking burns, even if the temperature has not reached 80 °C. Never touch the motor with bare hands.



If the temperature exceeds 80 °C, adjust the current value and operating interval.

CAUTION



Use the product within the withstand load and maximum speed indicated in the specifications. Failure to observe this maintain result in injury or damage. Also the specified accuracy cannot guaranteed.

2.6 Timing chart

Without sensor option

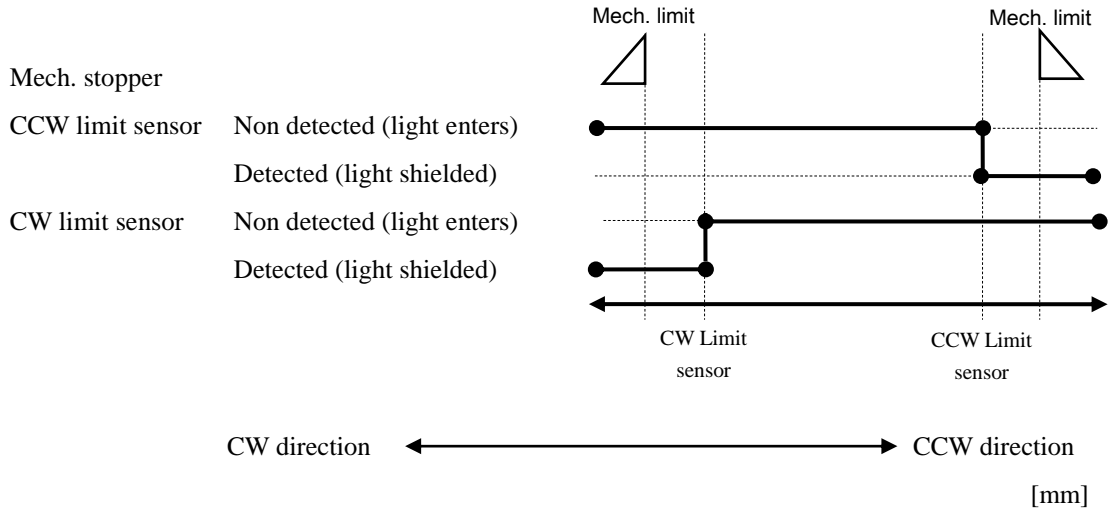

	Coordinate standard	Mech. limit	CW limit	CCW limit	Mech. limit
KXL06030 KZL06030	Stroke center	17.5	15.5	15.5	17.5
KXL06050 KZL06050	Stroke center	27.5	25.5	25.5	27.5
KXL06075 KZL06075	Stroke center	40	37.5	37.5	40
KXL06100	Stroke center	52.5	50.5	50.5	52.5
KXL06150	Stroke center	77.5	75.5	75.5	77.5
KXL06200	Stroke center	102.5	100.5	100.5	102.5
KXL06300	Stroke center	152.5	150.5	150.5	152.5

* The coordinates are design values. The actual coordinates may differ by a margin of error of approximately ± 0.5 mm.

* The timing chart indicates the sensor timing, and not output signal logic. Refer to the output transistor ON/OFF display indicated under sensor output logic in the electric specifications.

Sensor option 1 or 2

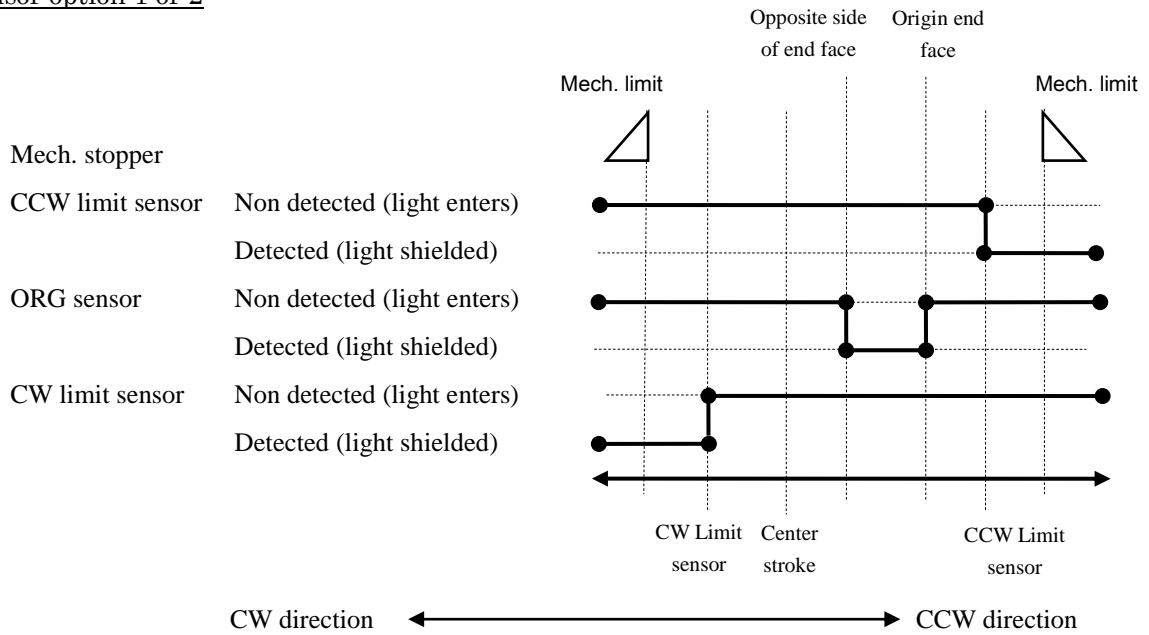

[mm]

	Coordinate standard	Mech. limit	CW limit	Opposite side of end face	Origin End face	CCW limit	Mech. limit
KXL06030 KZL06030	Stroke center	17.5	15.5	0	5	15.5	17.5
KXL06050 KZL06050	Stroke center	27.5	25.5	10	15	25.5	27.5
KXL06075 KZL06075	Stroke center	40	37.5	22.5	27.5	37.5	40
KXL06100	Stroke center	52.5	50.5	35	40	50.5	52.5
KXL06150	Stroke center	77.5	75.5	60	65	75.5	77.5
KXL06200	Stroke center	102.5	100.5	85	90	100.5	102.5
KXL06300	Stroke center	152.5	150.5	135	140	150.5	152.5

* The coordinates are design values. The actual coordinates may differ by a margin of error of approximately ± 0.5 mm.

* The timing chart indicates the sensor timing, and not output signal logic. Refer to the output transistor ON/OFF display indicated under sensor output logic in the electric specifications.

Sensor option 3 or 4.

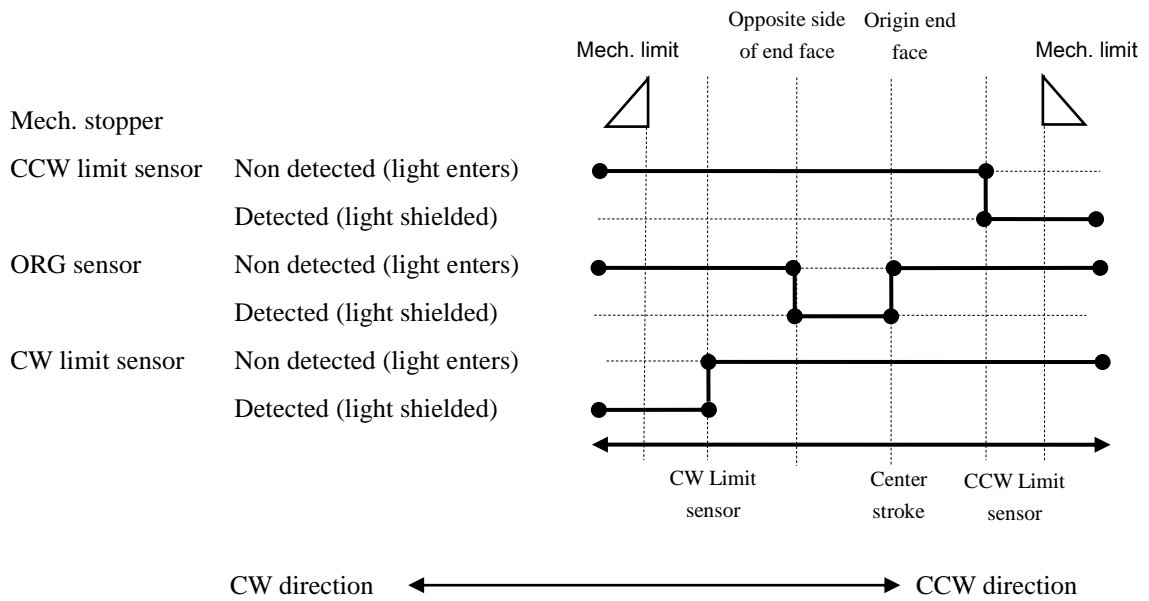

	Coordinate standard	Mech. limit	CW limit	Opposite side of end face	Origin End face	CCW limit	Mech. limit
KXL06030 KZL06030	Stroke center	17.5	15.5	5	0	15.5	17.5
KXL06050 KZL06050	Stroke center	27.5	25.5	5	0	25.5	27.5
KXL06075 KZL06075	Stroke center	40	37.5	5	0	37.5	40
KXL06100	Stroke center	52.5	50.5	5	0	50.5	52.5
KXL06150	Stroke center	77.5	75.5	5	0	75.5	77.5
KXL06200	Stroke center	102.5	100.5	5	0	100.5	102.5
KXL06300	Stroke center	152.5	150.5	5	0	150.5	152.5

* The coordinates are design values. The actual coordinates may differ by a margin of error of approximately ± 0.5 mm.

* The timing chart indicates the sensor timing, and not output signal logic. Refer to the output transistor ON/OFF display indicated under sensor output logic in the electric specifications.

Sensor option 5 or 6

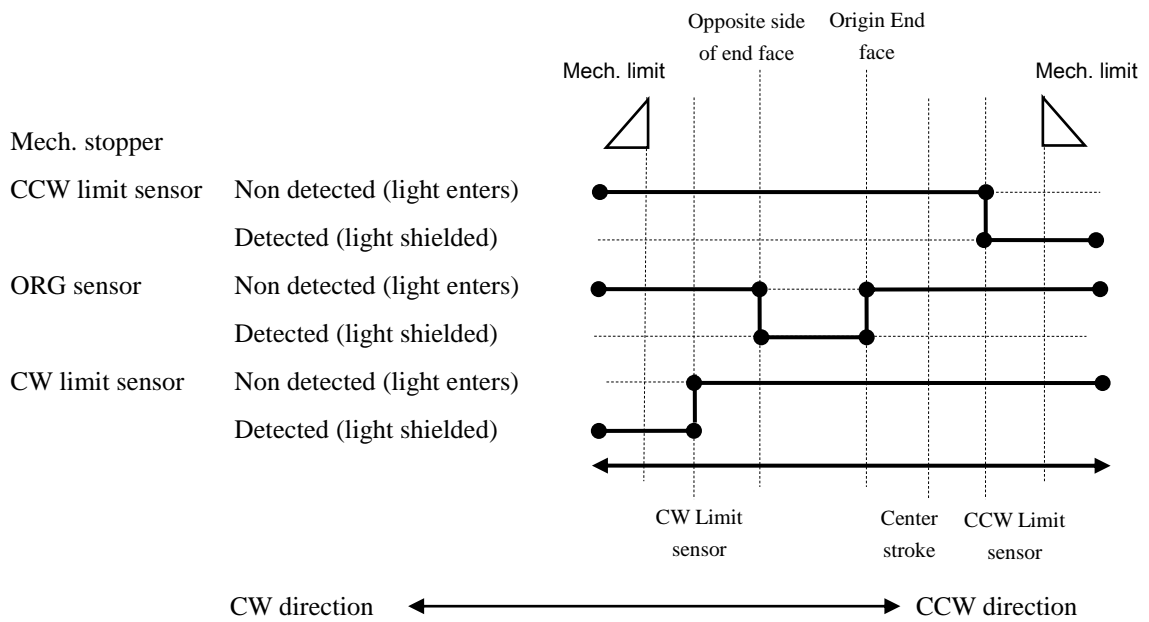

[mm]

	Coordinate standard	Mech. limit	CW limit	Opposite side of end face	Origin End face	CCW limit	Mech. limit
KXL06030 KZL06030	Stroke center	17.5	15.5	5	0	15.5	17.5
KXL06050 KZL06050	Stroke center	27.5	25.5	15	10	25.5	27.5
KXL06075 KZL06075	Stroke center	40	37.5	27.5	22.5	37.5	40
KXL06100	Stroke center	52.5	50.5	40	35	50.5	52.5
KXL06150	Stroke center	77.5	75.5	65	60	75.5	77.5
KXL06200	Stroke center	102.5	100.5	90	85	100.5	102.5
KXL06300	Stroke center	152.5	150.5	140	135	150.5	152.5

* The coordinates are design values. The actual coordinates may differ by a margin of error of approximately ± 0.5 mm.

* The timing chart indicates the sensor timing, and not output signal logic. Refer to the output transistor ON/OFF display indicated under sensor output logic in the electric specifications.

 **WARNING**



Depending on the table operating position, there is a possibility that hands may be trapped, potentially resulting in injury.

Never touch the product while in the drive status.

 **CAUTION**



Do not manually rotate the motor knob and move the product beyond its limit when the table is at the stroke end. Failure to observe this may result in damage to the product.

2.7 Product Dimensions

KXL06030-N1-C/G

KXL06030-N2-C/G

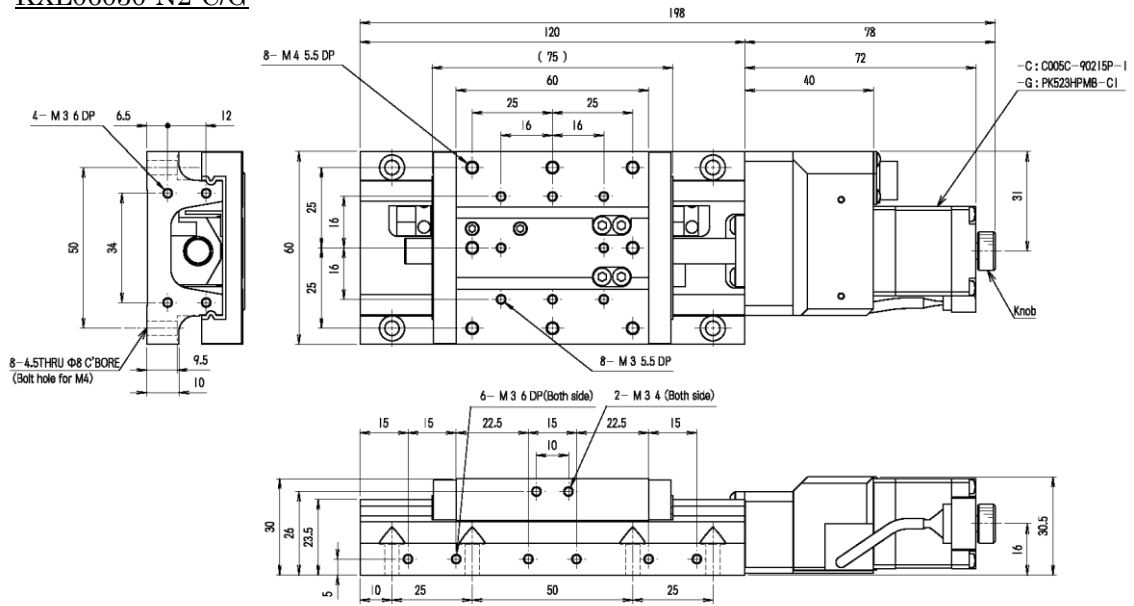

KXL06030-C1-C/G

KXL06030-C2-C/G

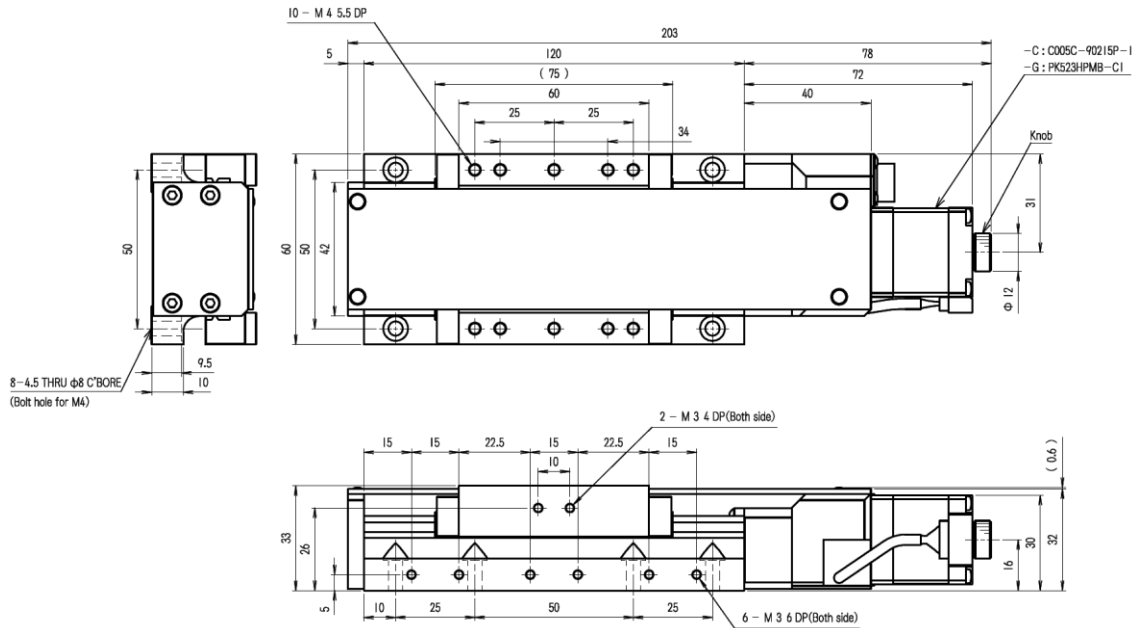

KXL06030-N1-F

KXL06030-N2-F

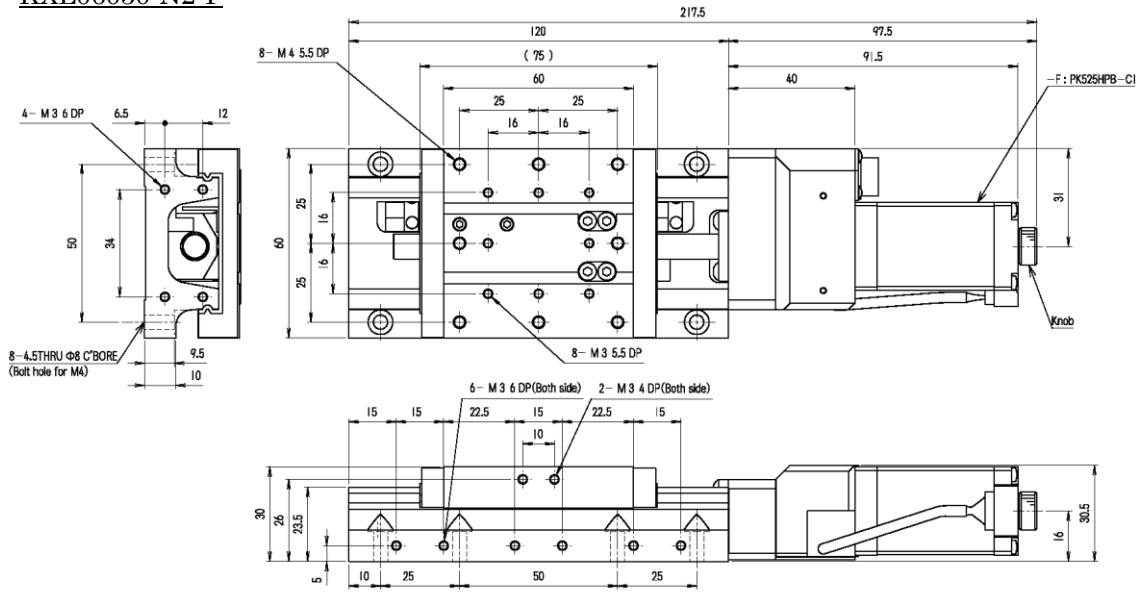

KXL06030-C1-F

KXL06030-C2-F

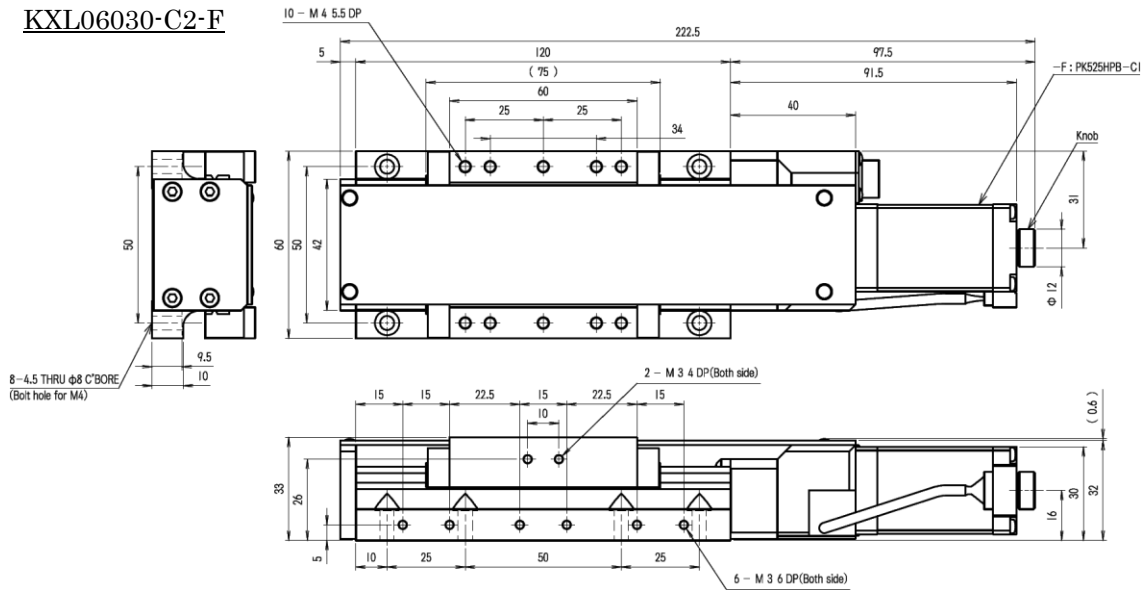

KXL06050-N1-C/G

KXL06050-N2-C/G

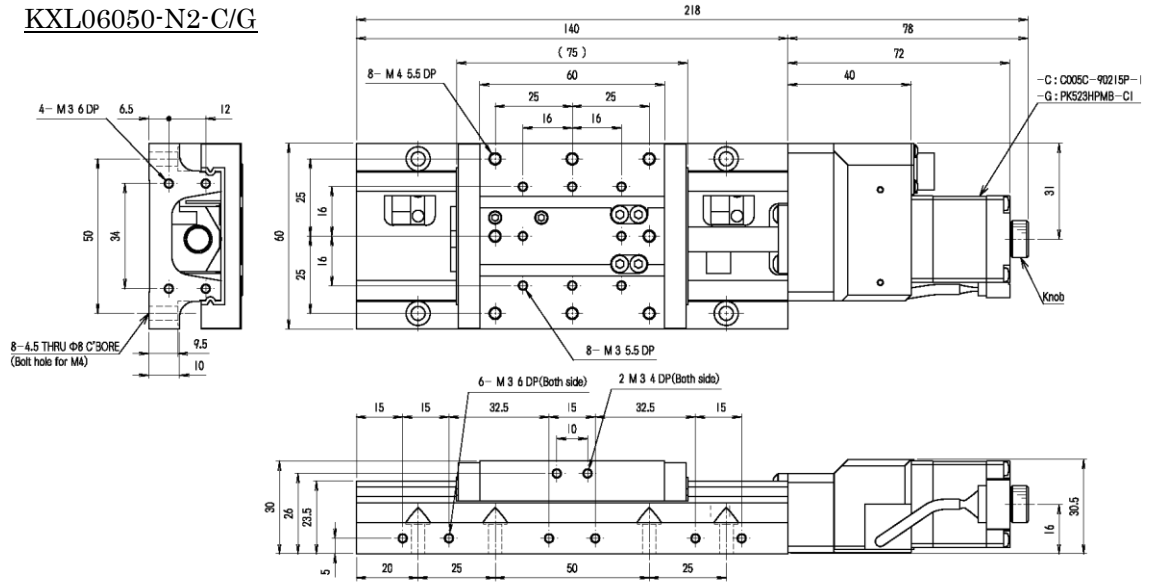

KXL06050-C1-C/G

KXL06050-C2-C/G

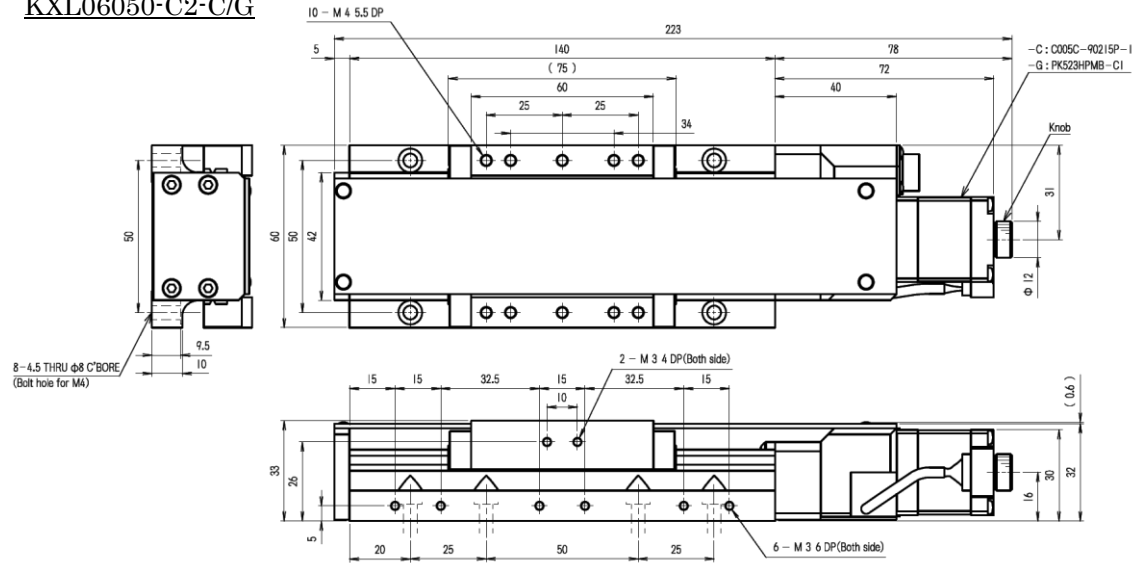

KXL06050-N1-F

KXL06050-N2-F

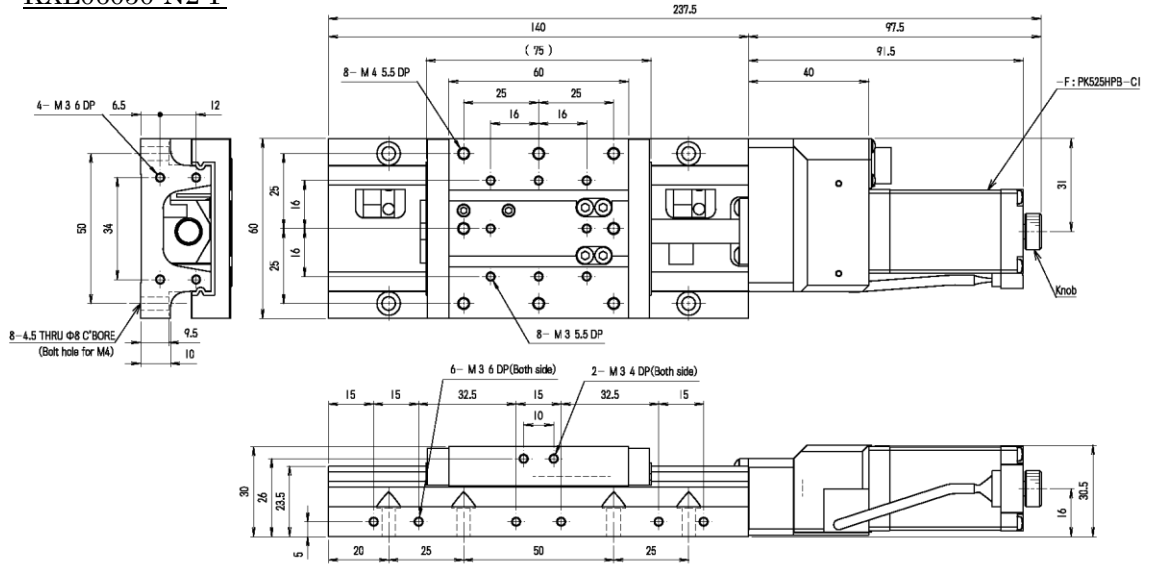

KXL06050-C1-F

KXL06050-C2-F

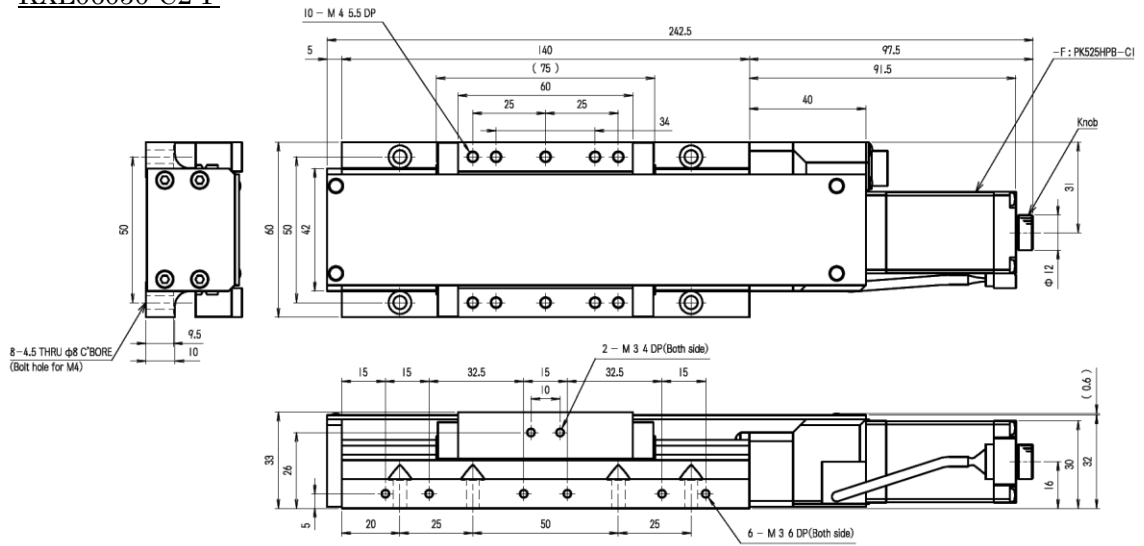

KXL06075-N1-C/G

KXL06075-N2-C/G

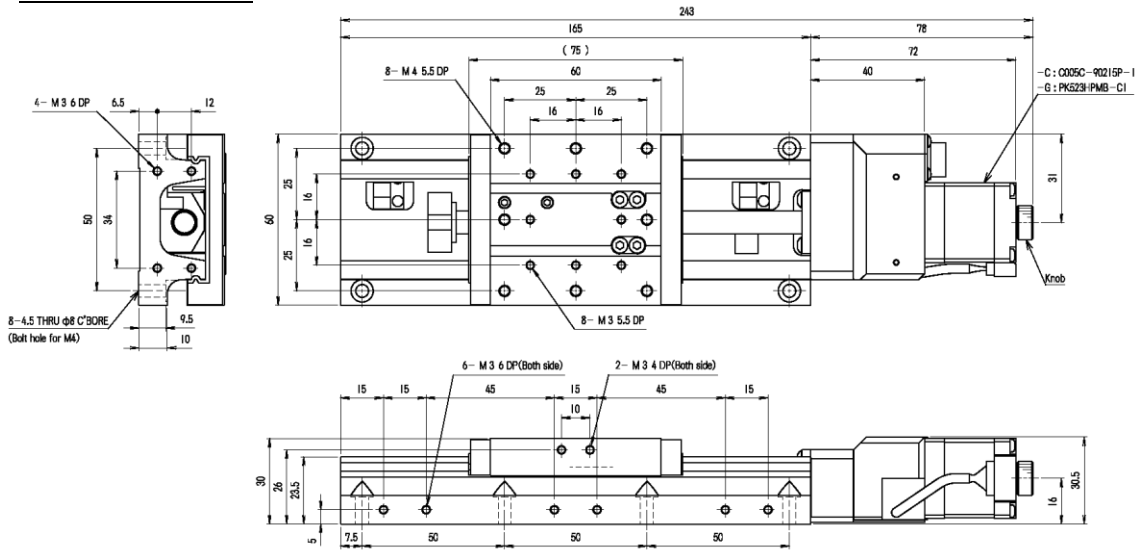

KXL06075-C1-C/G

KXL06075-C2-C/G

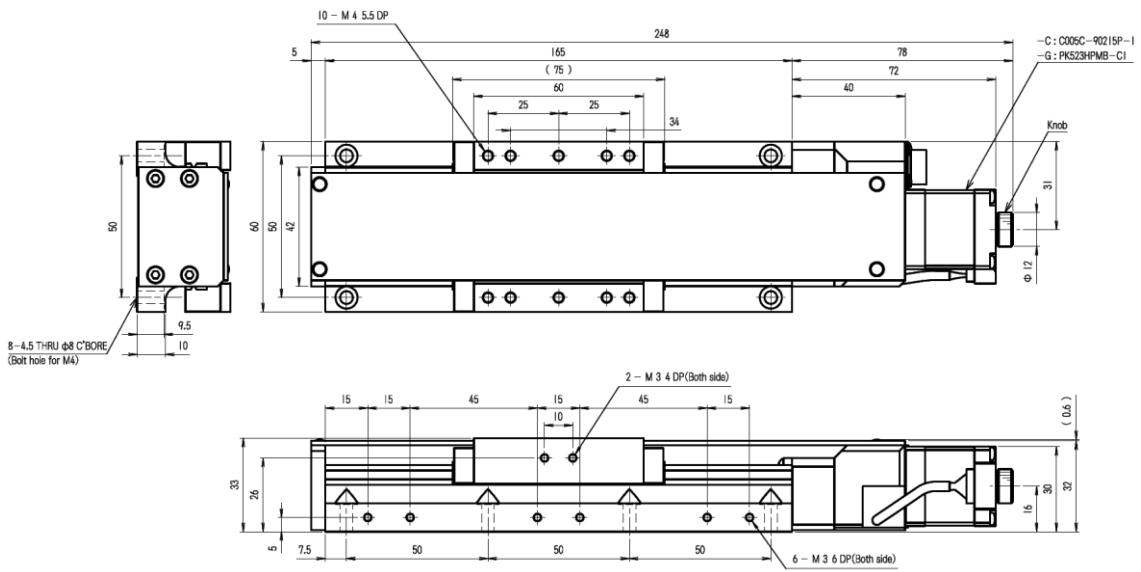

KXL06075-N1-F

KXL06075-N2-F

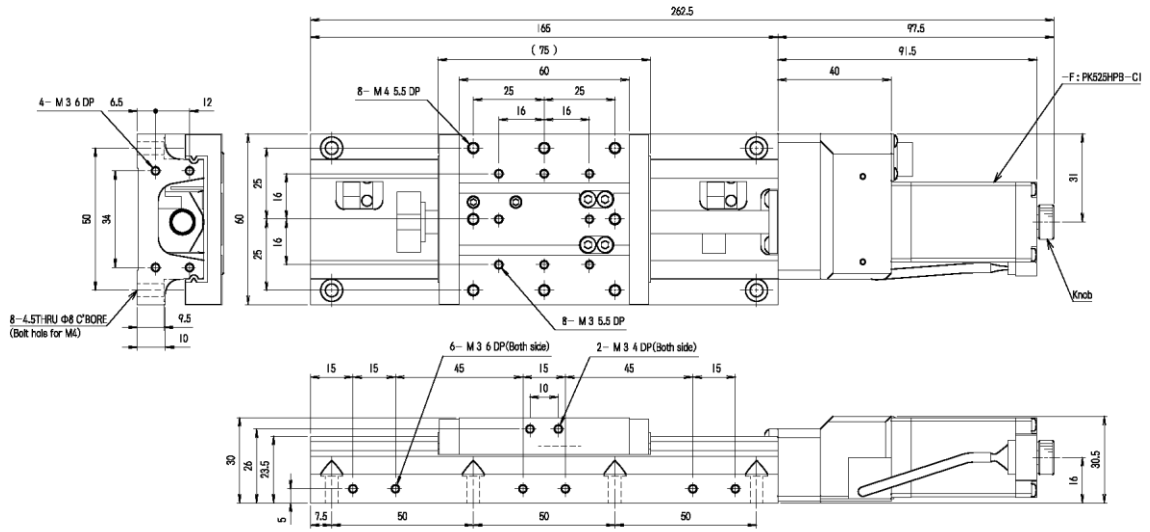

KXL06075-C1-F

KXL06075-C2-F

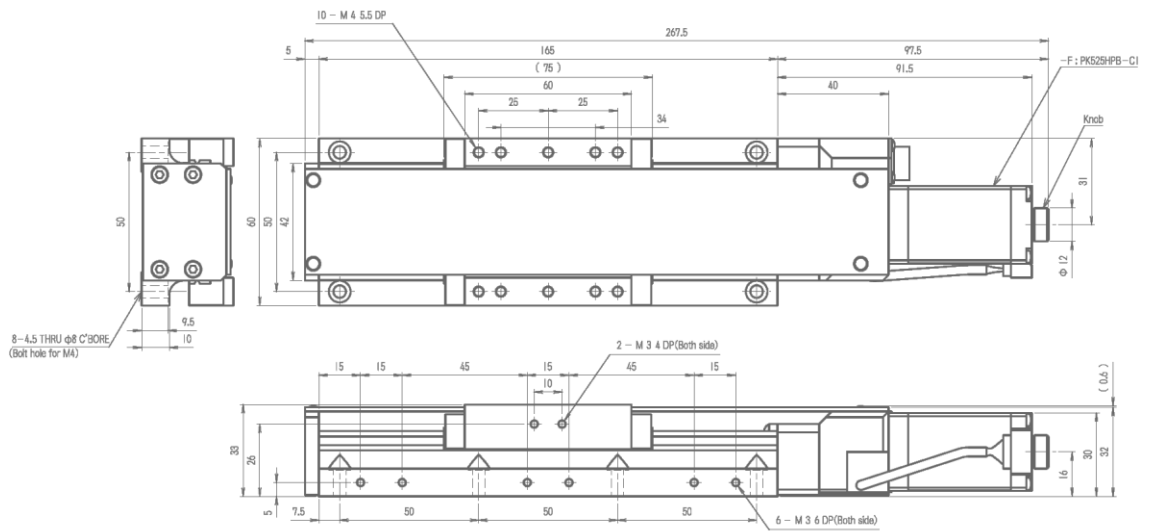

KXL06100-N2-F

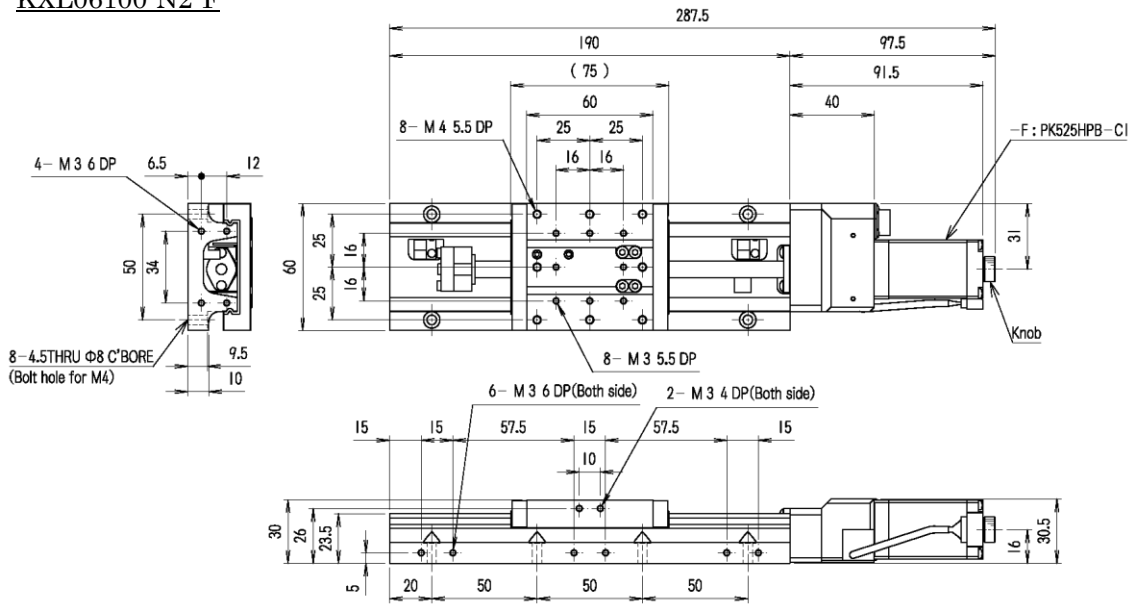

KXL06100-C2-F

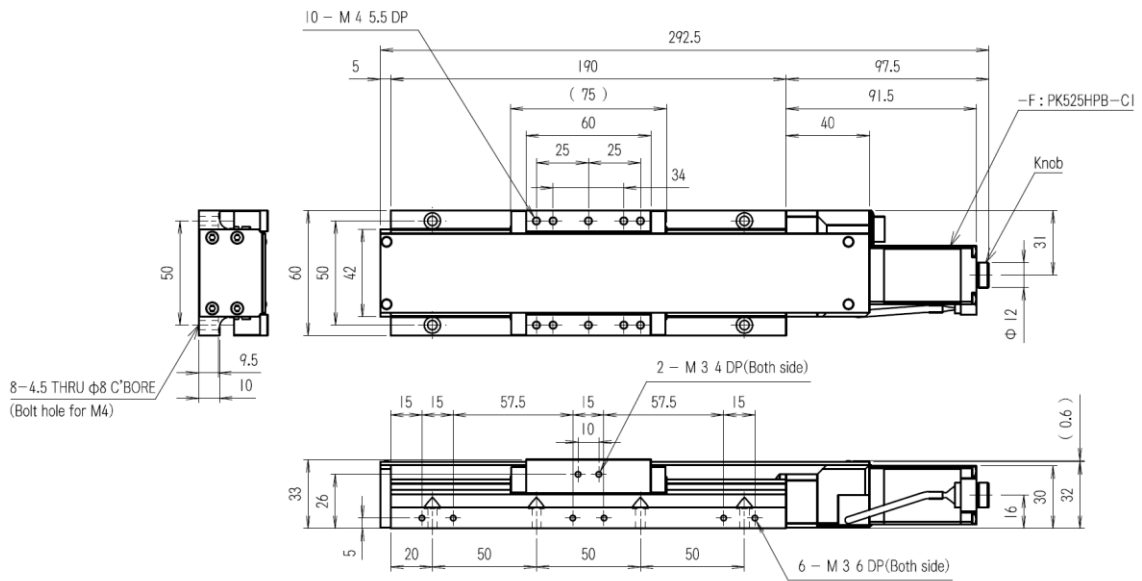

KXL06100-N2-G

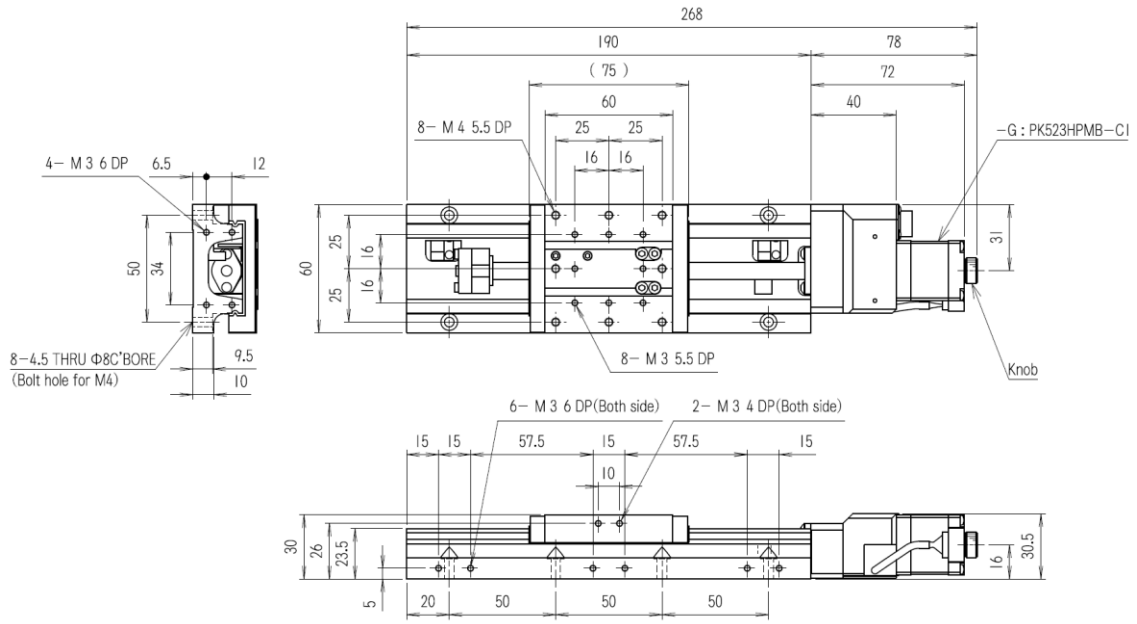

KXL06100-C2-G

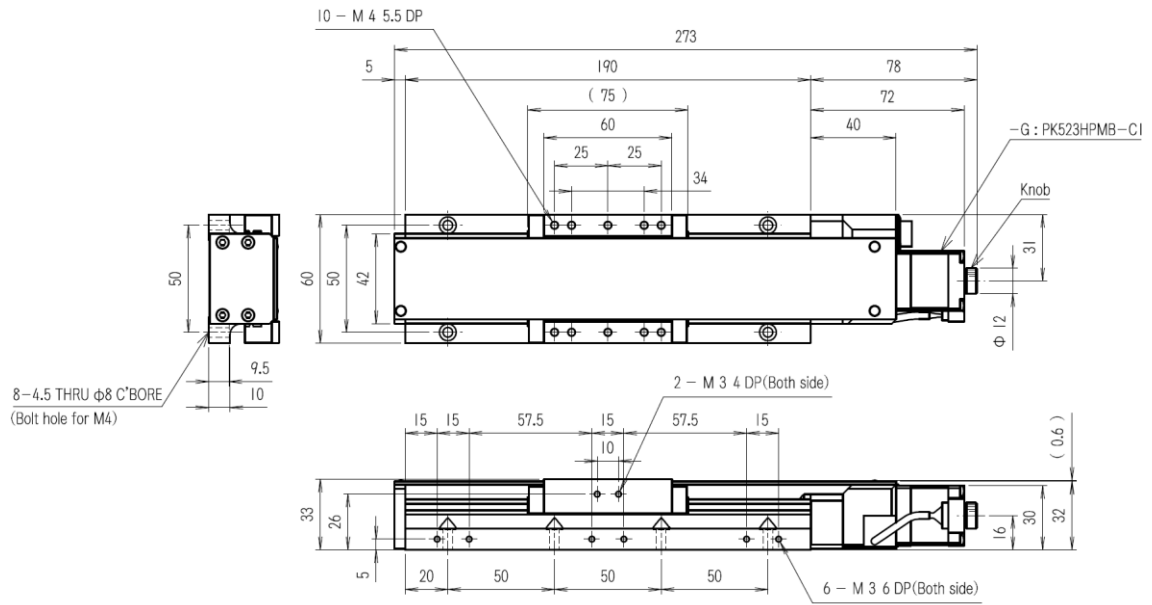

KXL06150-N2-F

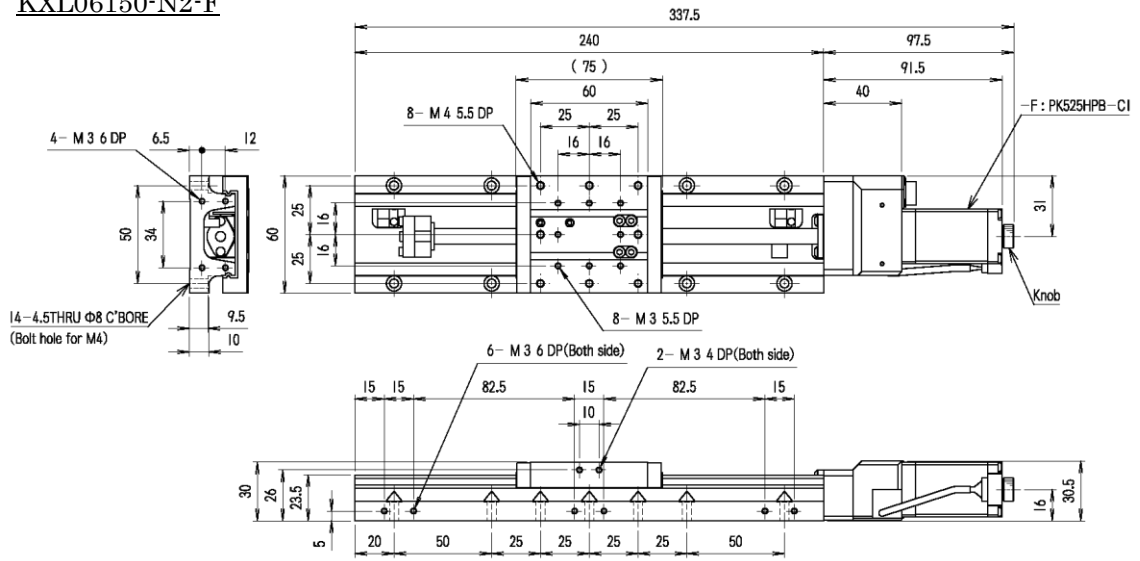

KXL06150-C2-F

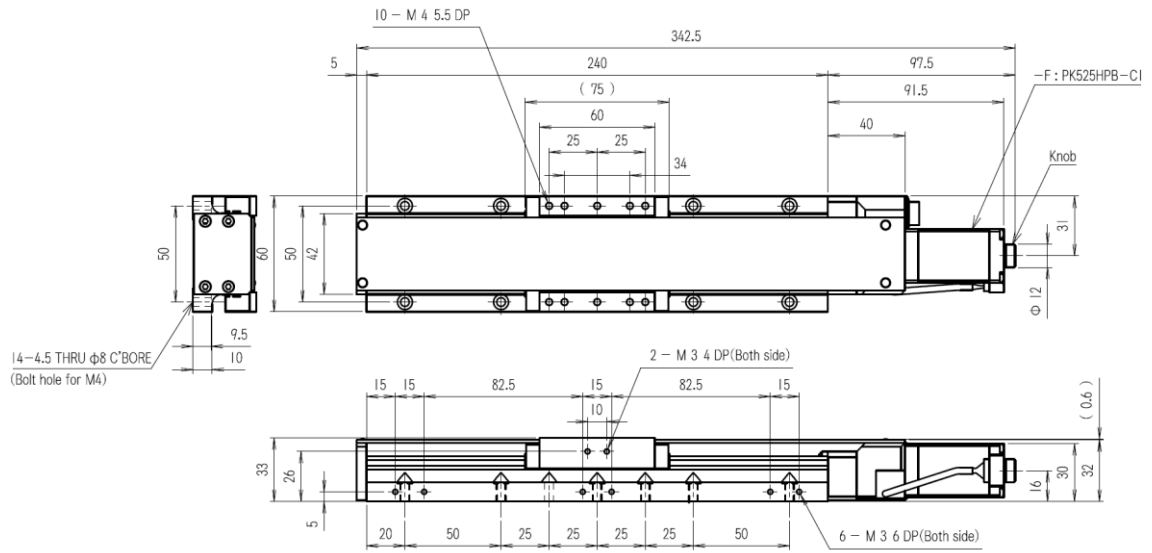

KXL06150-N2-G

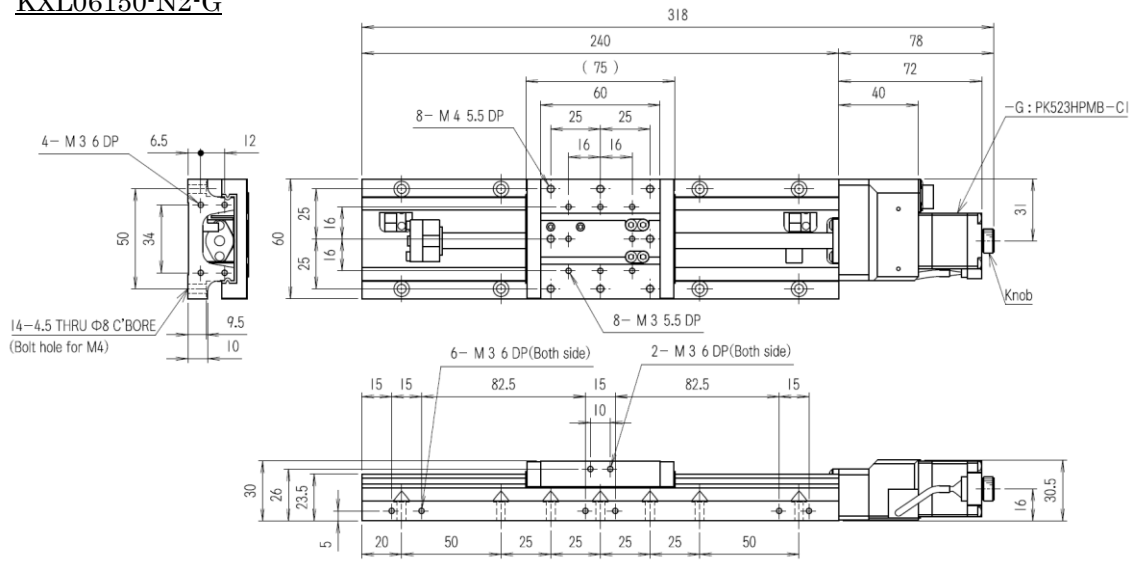

KXL06150-C2-G

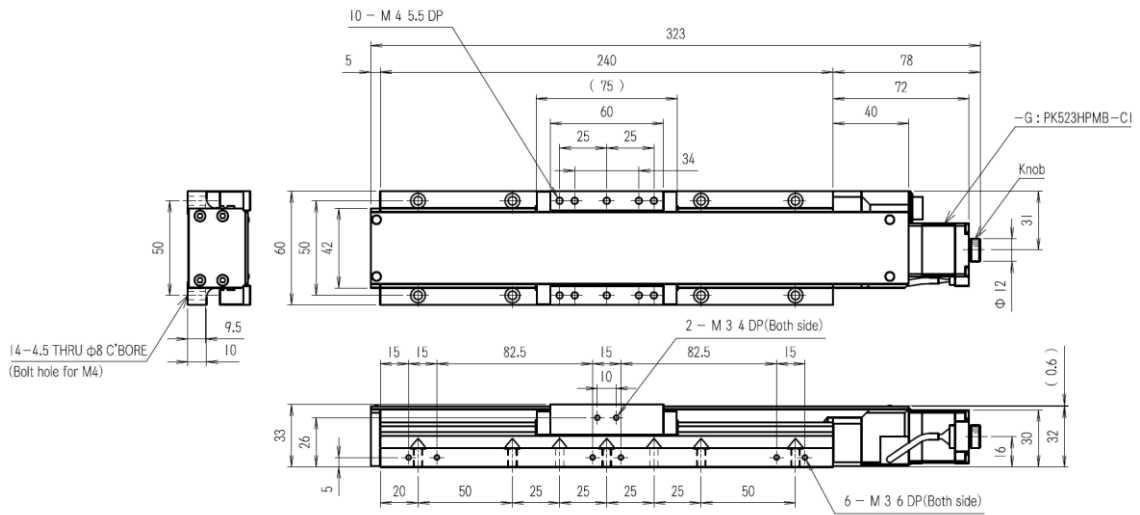

KXL06200-N2-F

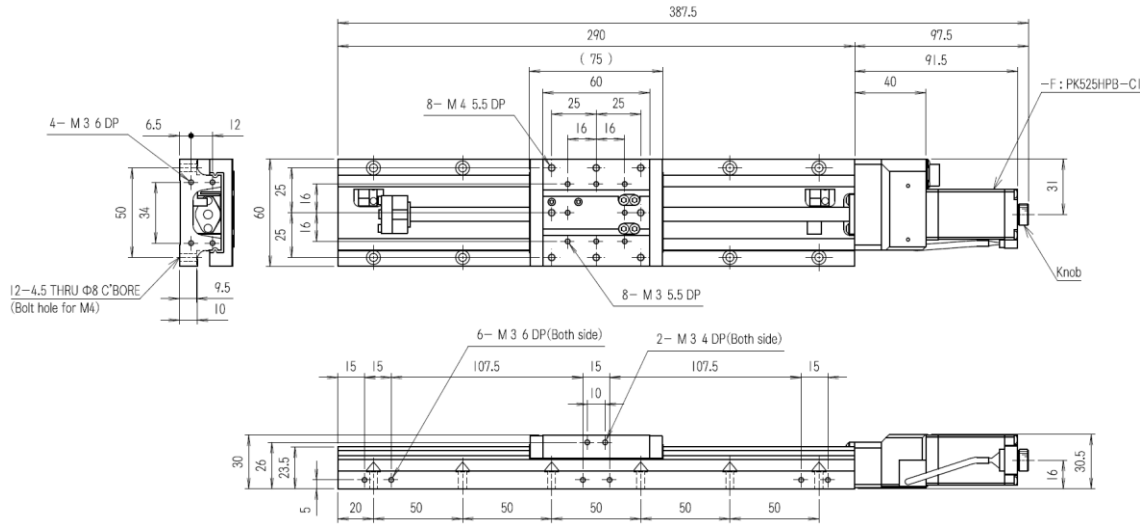

KXL06200-C2-F

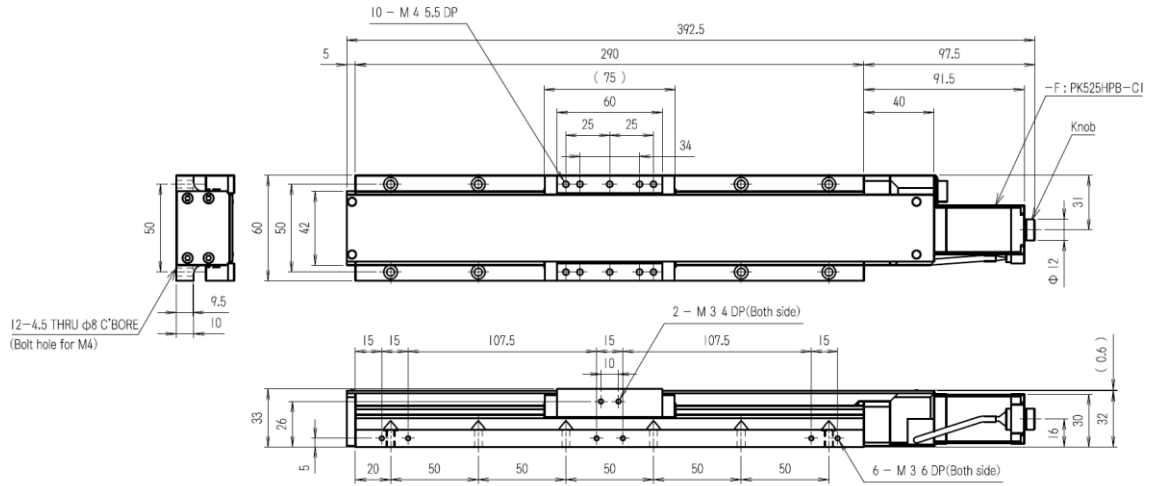

KXL06200-N2-G

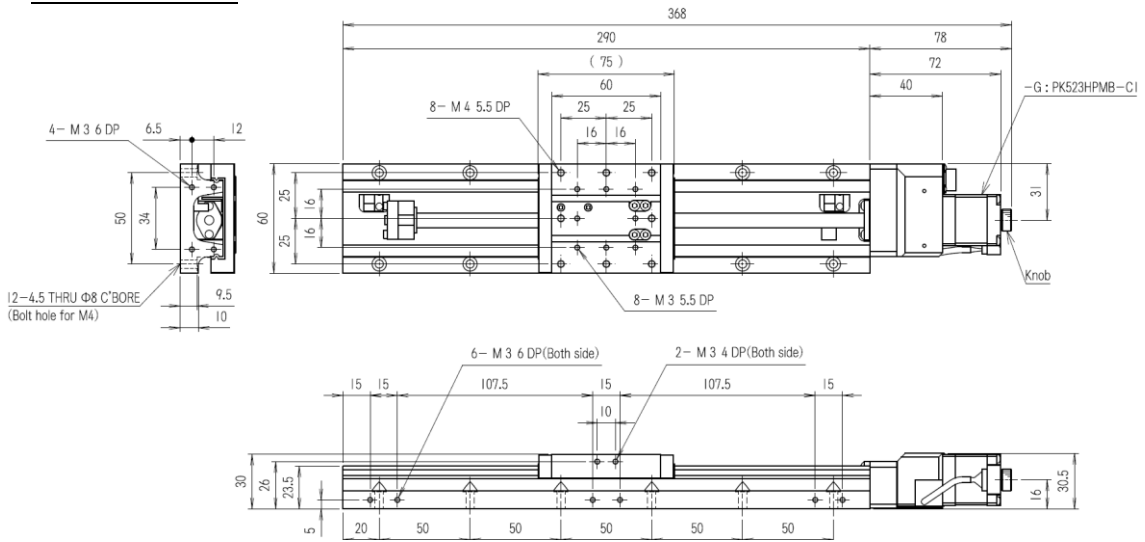

KXL06200-C2-G

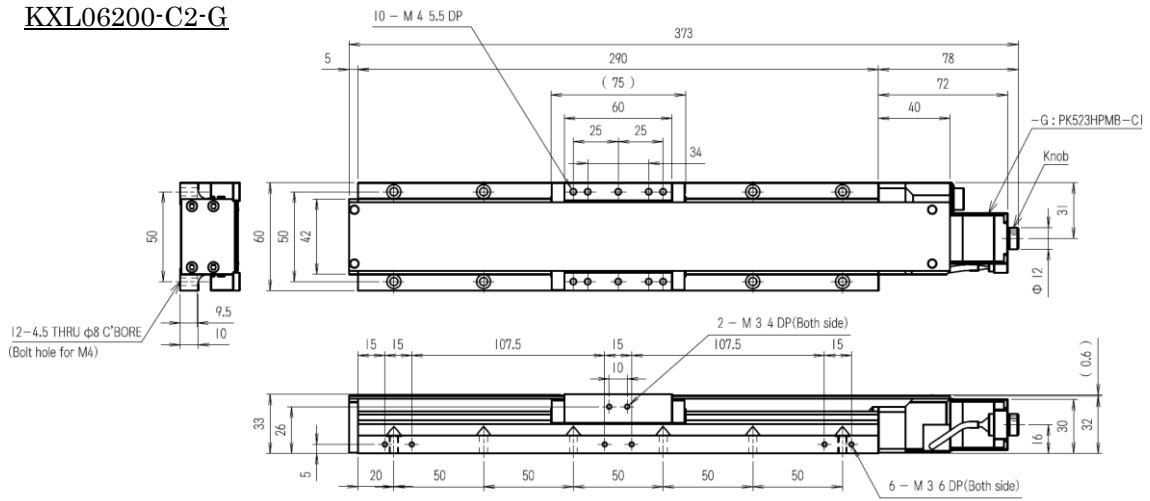

KXL06300-N2-F

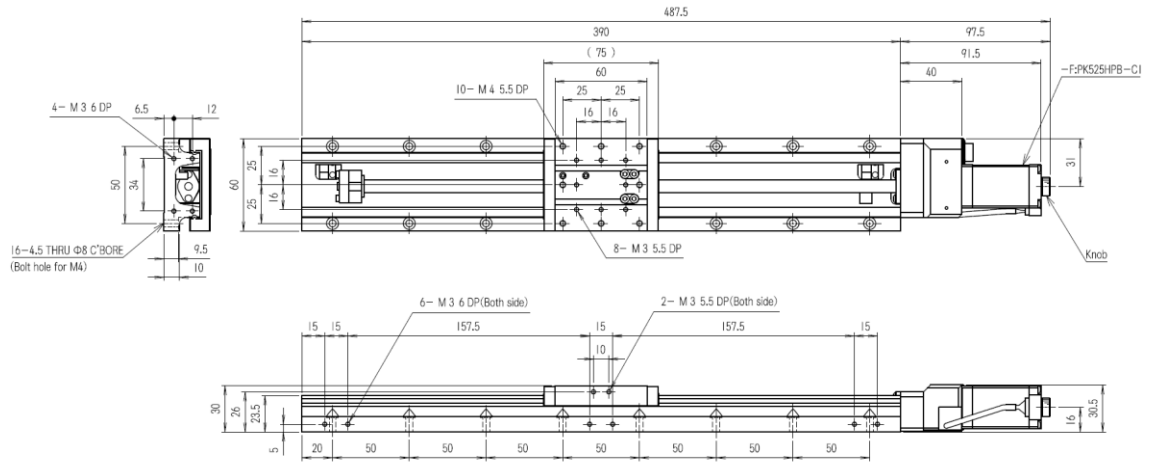

KXL06300-C2-F

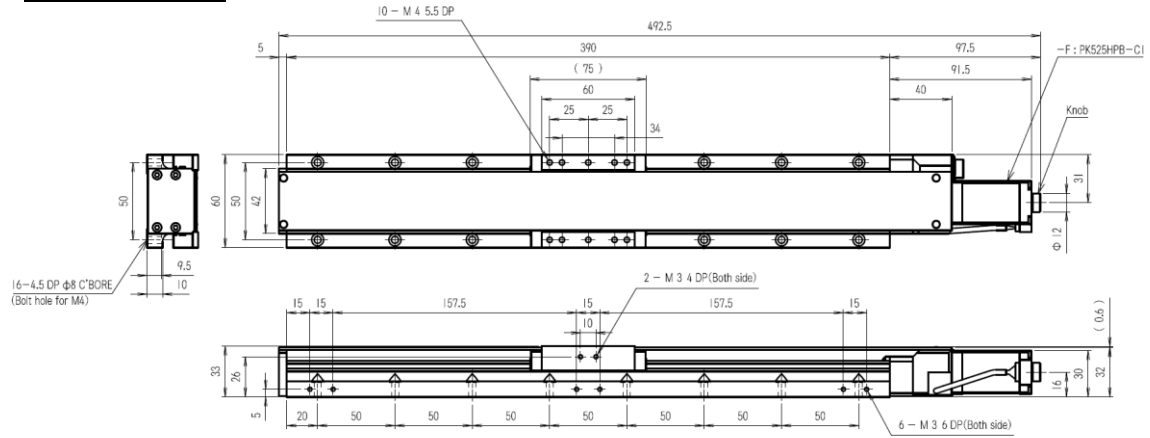

KXL06300-N2-G

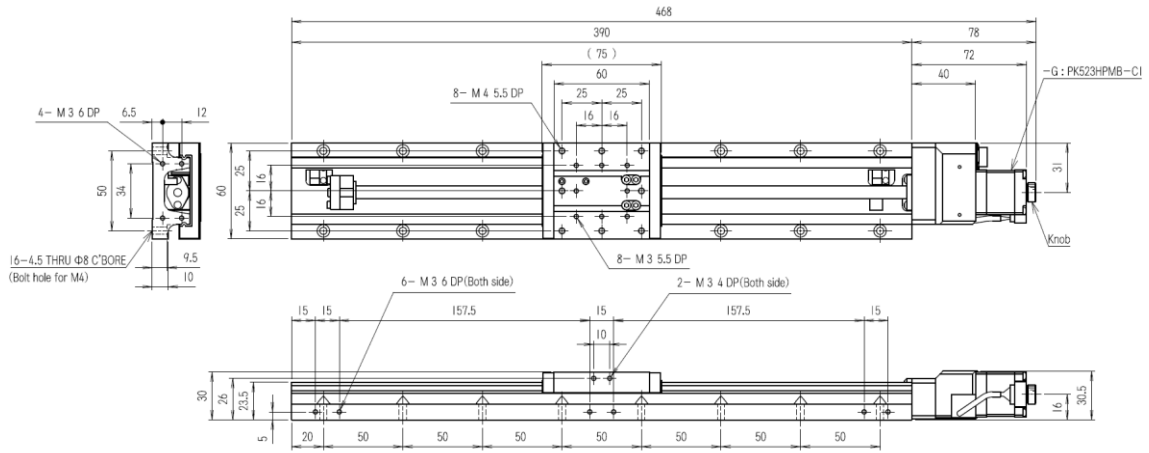

KXL06300-C2-G

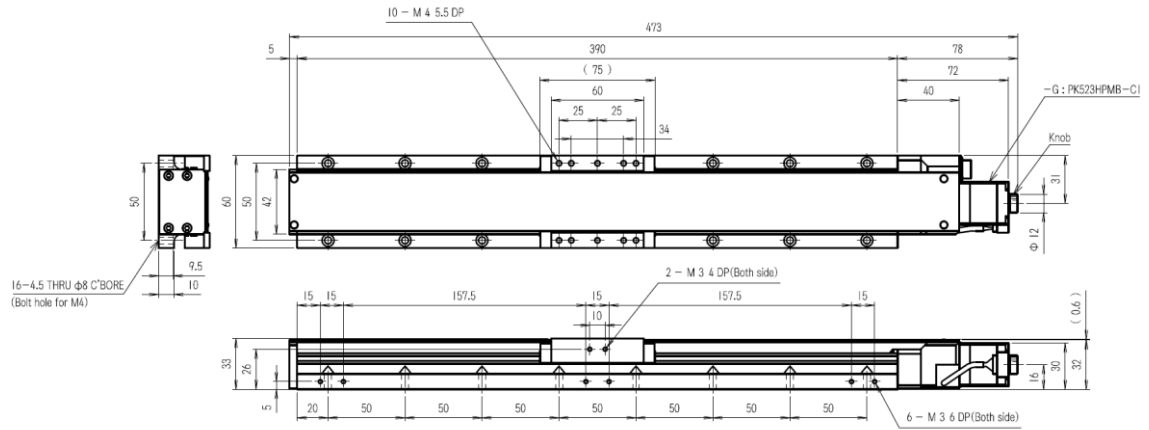

KZL06030-N1-C/G

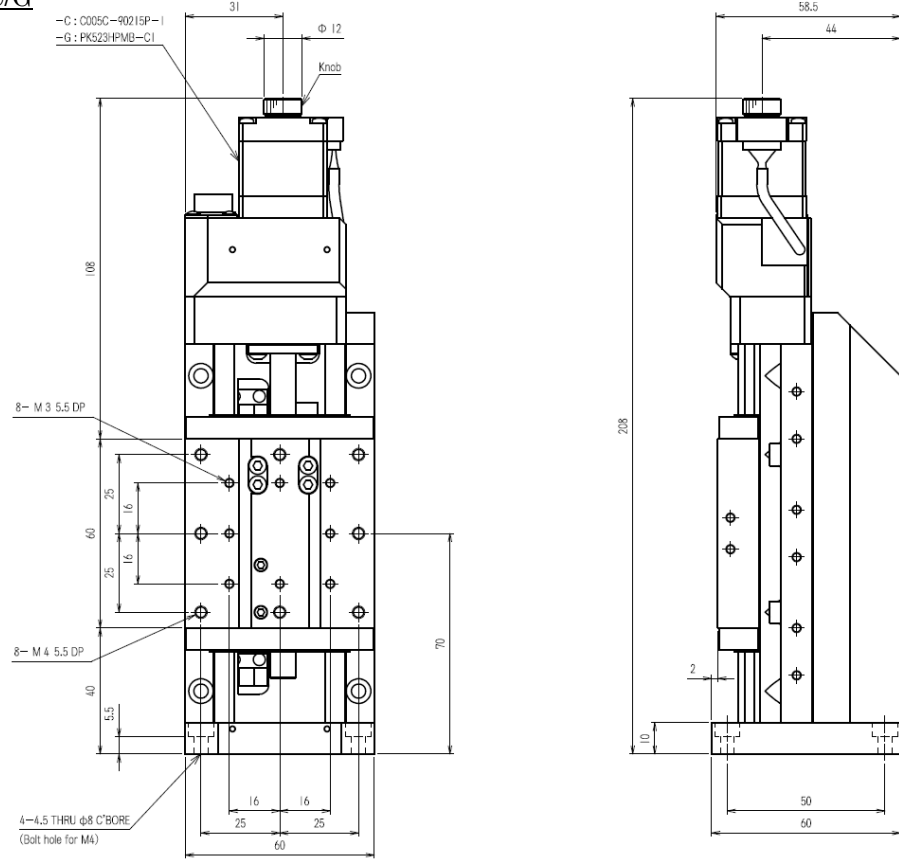

KZL06030-C1-C/G

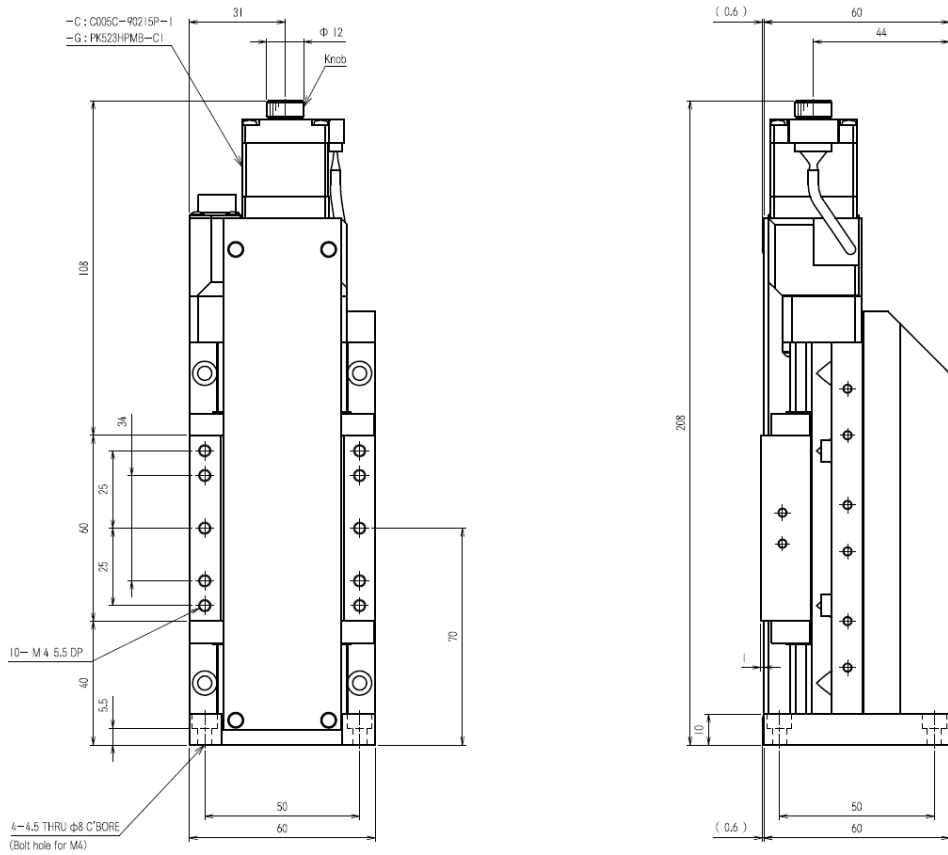

KZL06030-N1-F

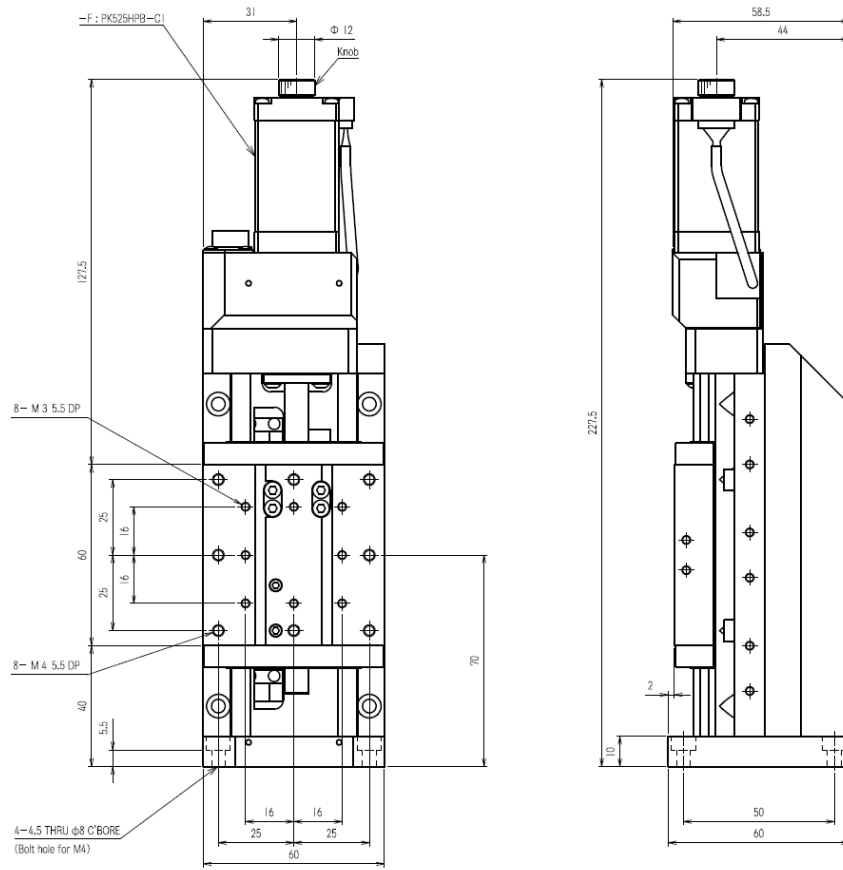

KZL06030-C1-F

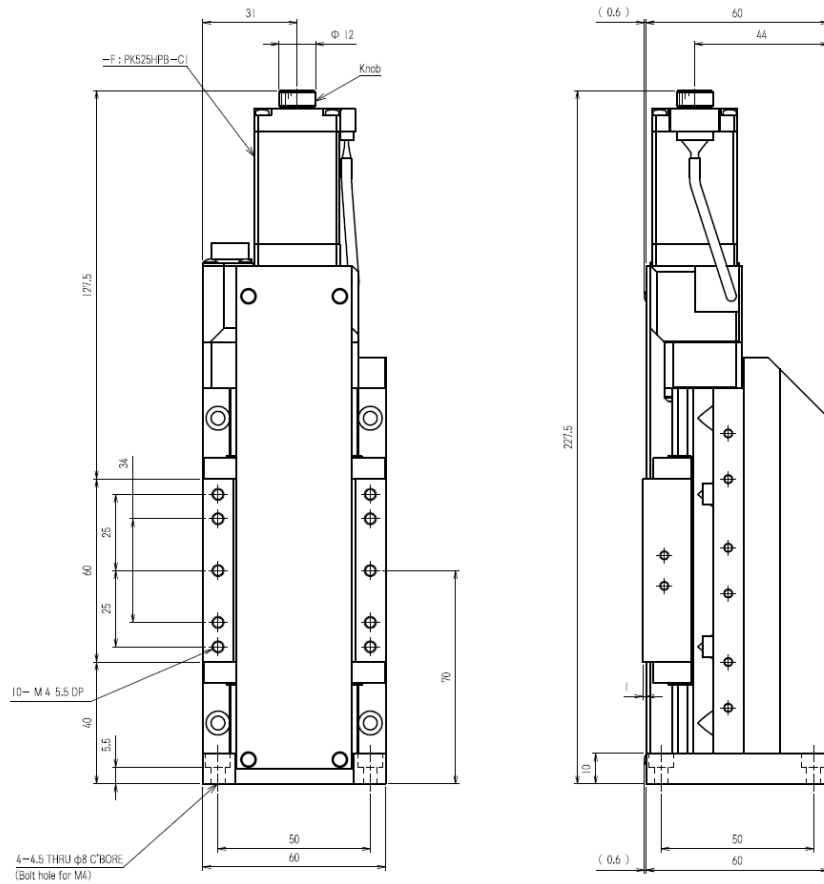

KZL06050-N1-C/G

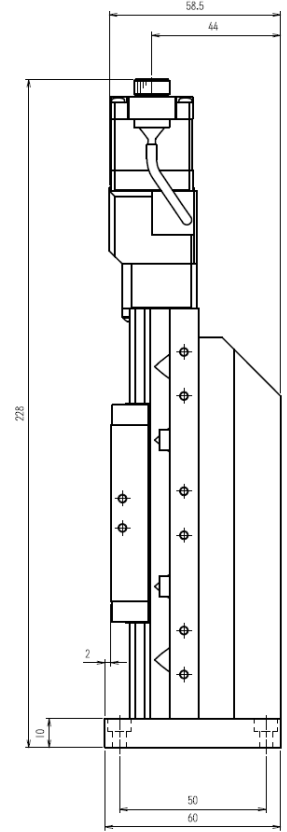
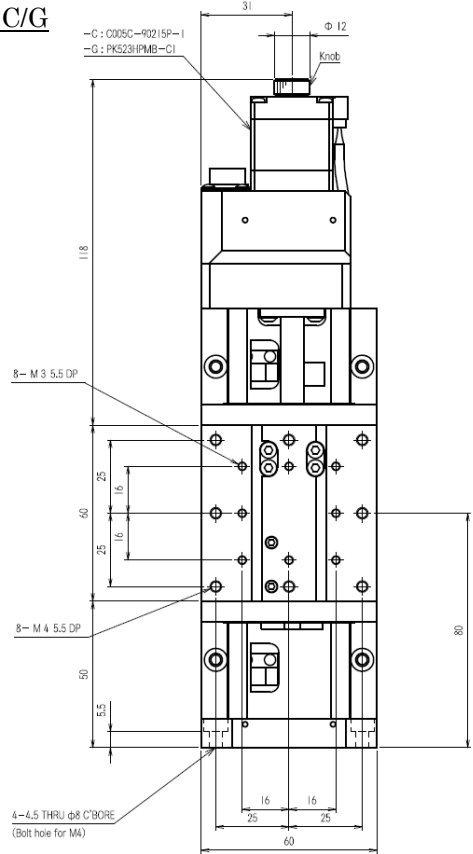

KZL06050-C1-C/G

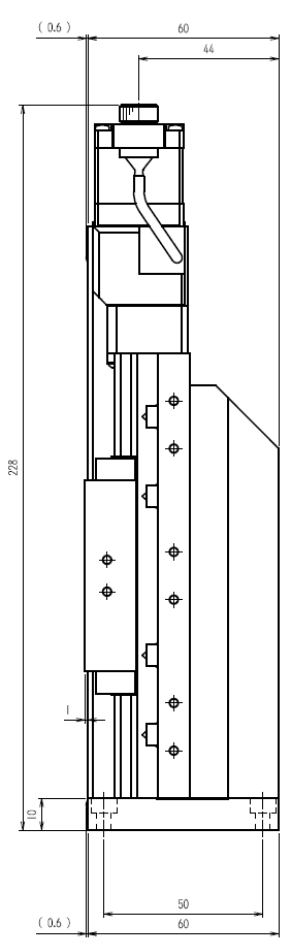
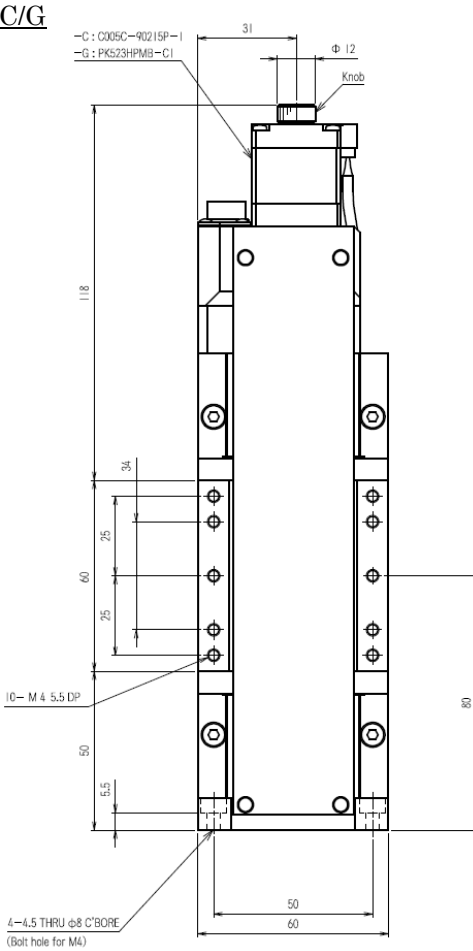

KZL06050-N1-F

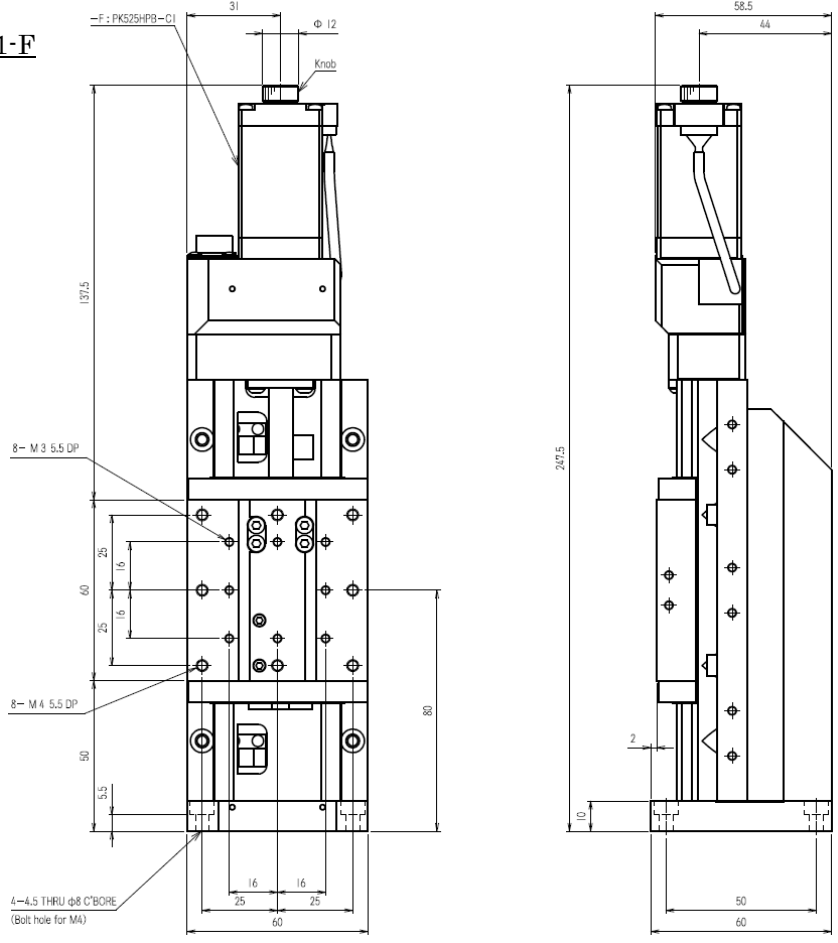

KZL06050-C1-F

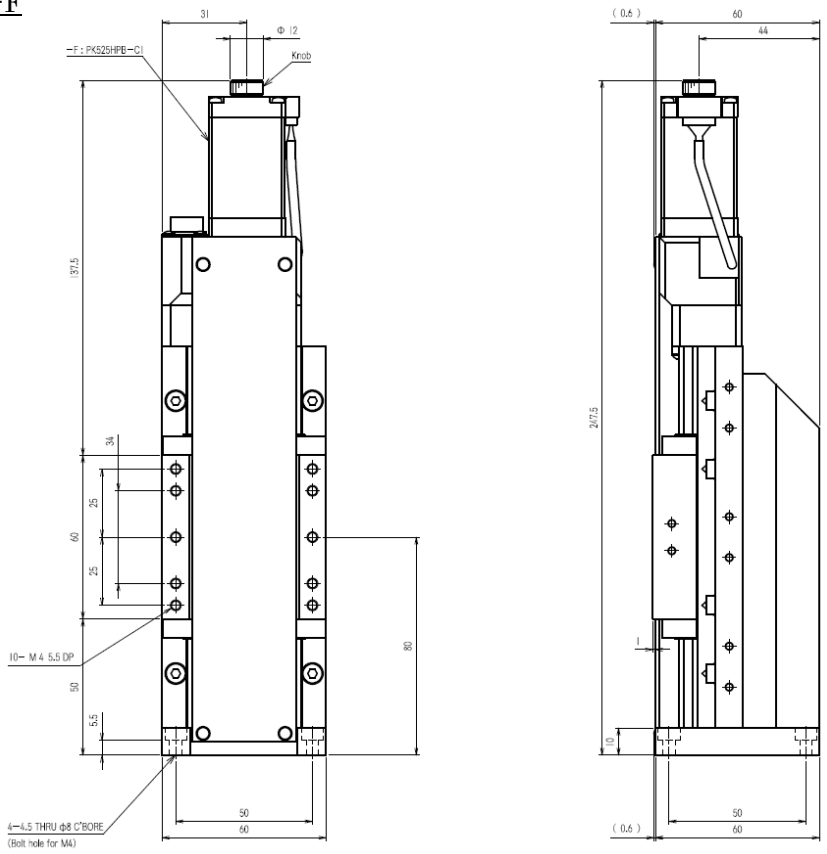

KZL06075-N1-C/G

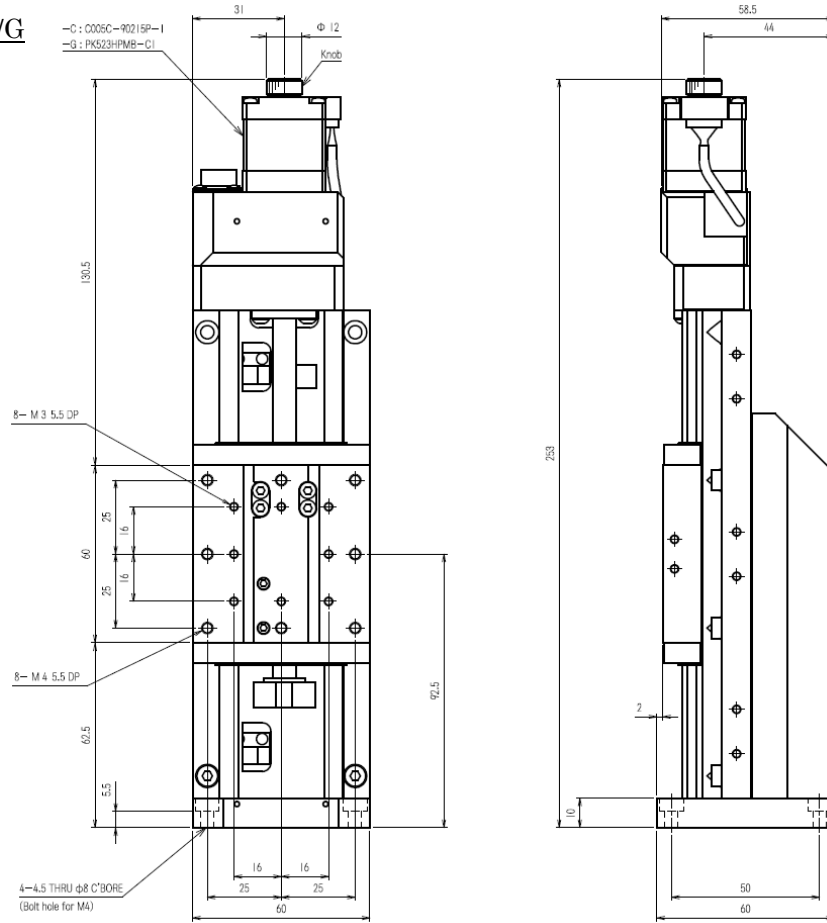

KZL06075-C1-C/G

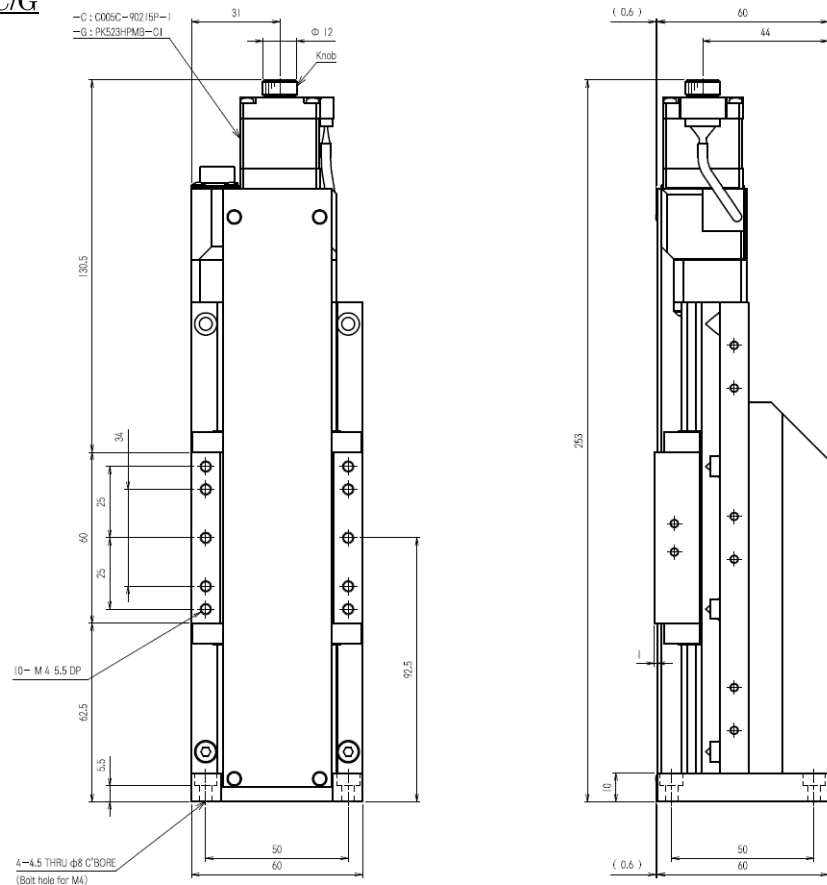

KZL06075-N1-F

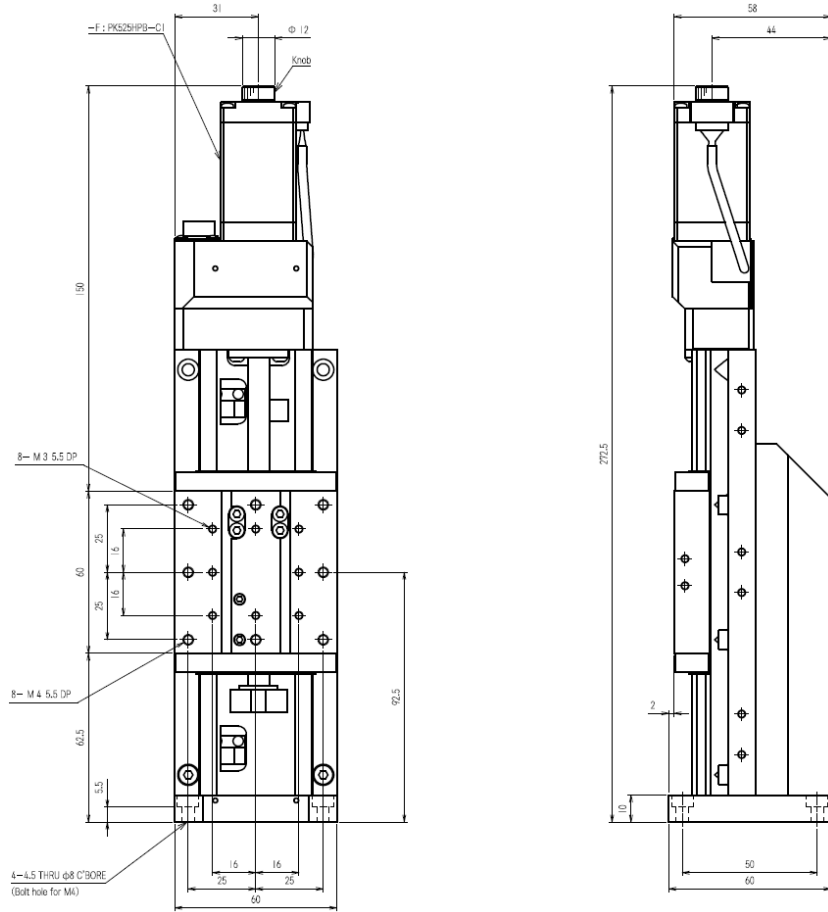

KZL06075-C1-F

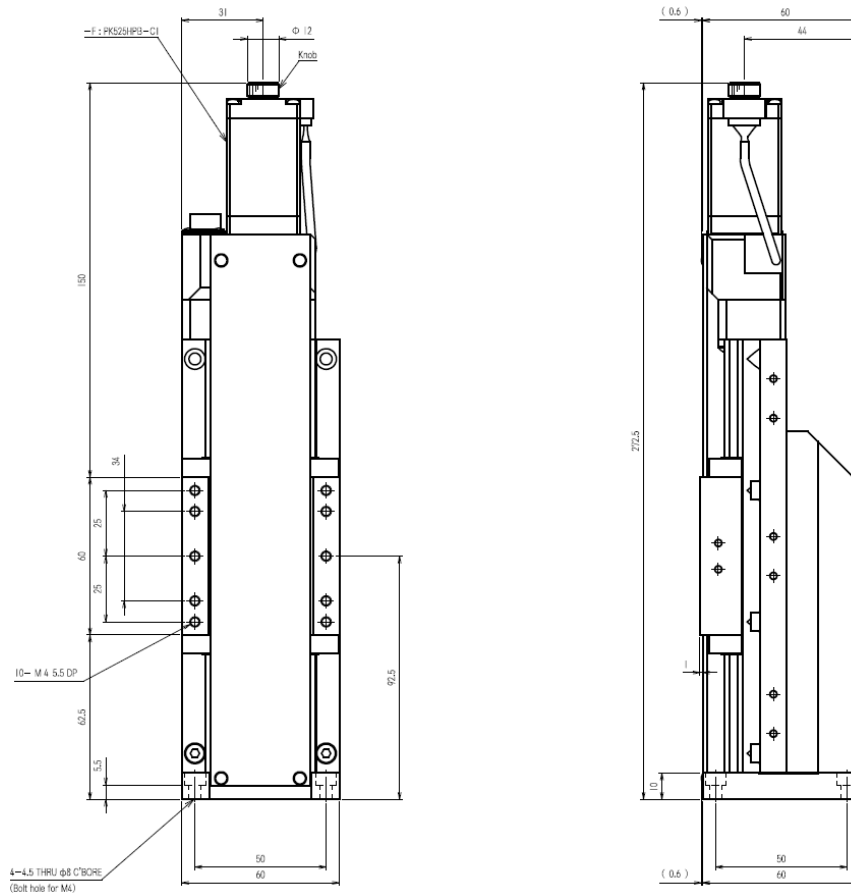



Do not exceed the usable depth indicated at tapped holes. Failure to observe this may result in damage to the stage.

2.8 Connection

- **System configuration**

The system configuration of this product is as follows.

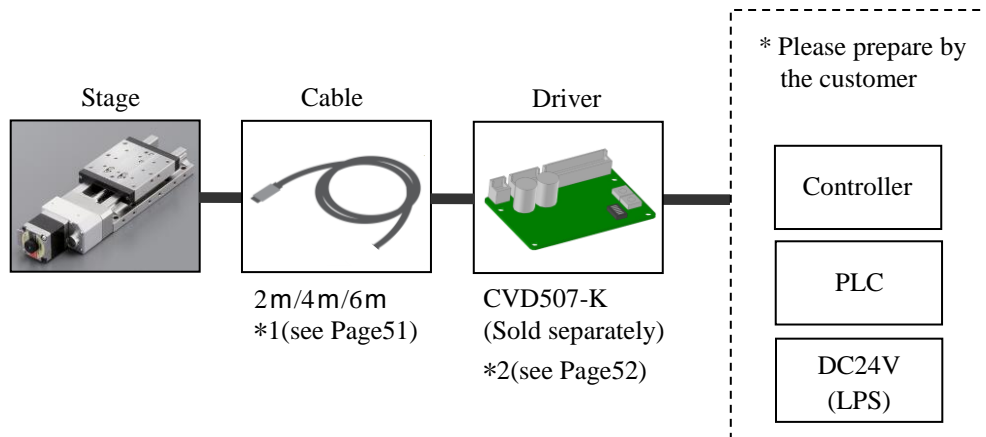

* 1 Specified cable (SURUGA SEIKI)

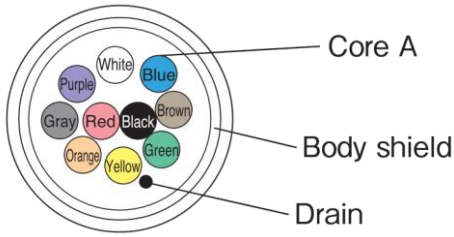
SPEC			
Option code	B	D	- (Sold separately)
Model number	D214 - 2 - 2EK	D214 - 2 - 4EK	D214 - 2 - 6EK
Existence of connector	One end (driver side) loose wire		
Connector on driver side	-		
Connector on Stage side	HR10A - 10P - 12S(73) (Hirose Electric Co., Ltd.)		
Cable length	2 m	4 m	6 m
Minimum bending radius	R33 mm		
Colour of insulator			

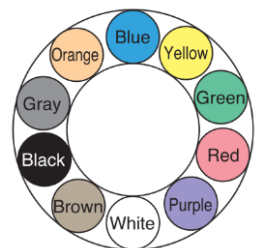
SPEC			
Option code	G	J	- (Sold separately)
Model number	D214 - 2 - 2RK	D214 - 2 - 4RK	D214 - 2 - 6RK
Existence of connector	One end (driver side) loose wire		
Connector on driver side	-		
Connector on Stage side	HR10A - 10P - 12S(73) (Hirose Electric Co., Ltd.)		
Cable length	2 m	4 m	6 m
Minimum bending radius	R33 mm		
Colour of insulator			

* 2 Specified driver (sold separately)

SPEC	
Model number	CVD507 - K (Oriental motor Co., Ltd.)
Applicable motor	C005C-90215P-1, PK525HPB-C1, PK523HPMB-C1
Input power	DC24 V \pm 10% 1.4 A (Max)
Rated current	0.75 A/phase
Number of partitions	1 ~ 1/250
Use temperature range	0 ~ 50°C
Outside dimension	65(W) x 45(D) x 21(H) mm
Weight	0.02 kg
Signal input	Photo coupler input

● Pin allocation

• Stage

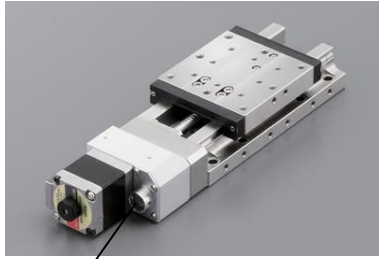

Connector

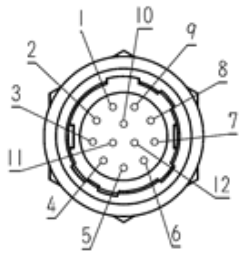

HR10A-10R-12P(73)

(Hirose Electric Co., Ltd.)

Pin	Signal	The function of terminal
1	Motor	Motor lead (Blue)
2		Motor lead (Red)
3		Motor lead (Orange)
4		Motor lead (Green)
5		Motor lead (Black)
6	CWLS	CW limit sensor output
7	CCWLS	CCW limit sensor output
8	-	Open
9	Power(+)	Sensor Power (DC5-24 V)
10	ORG	ORG sensor output
11	Power(-)	GND
12	F.G	F.G.

• Stage cable (D214-2-2EK, D214-2-4EK, D214-2-6EK,
D214-2-2RK, D214-2-4RK, D214-2-6RK)



Driver side

Stage side

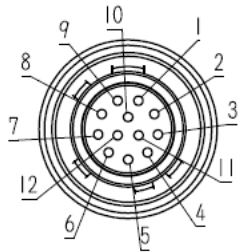

HR10A-10P-12S(73)

(Hirose Electric Co., Ltd.)

Pin	The function of terminal	Colour
1	Motor lead	Blue
2	Motor lead	Red
3	Motor lead	Orange
4	Motor lead	Green
5	Motor lead	Black
6	CW limit sensor output	Brown
7	CCW limit sensor output	Yellow
8	GND	—
9	Sensor Power (DC5-24 V)	Gray
10	ORG sensor output	Purple
11	GND	White
12	F.G.	—

* This cable has one end (driver side) loose wire

- Example of wiring

Without sensor option

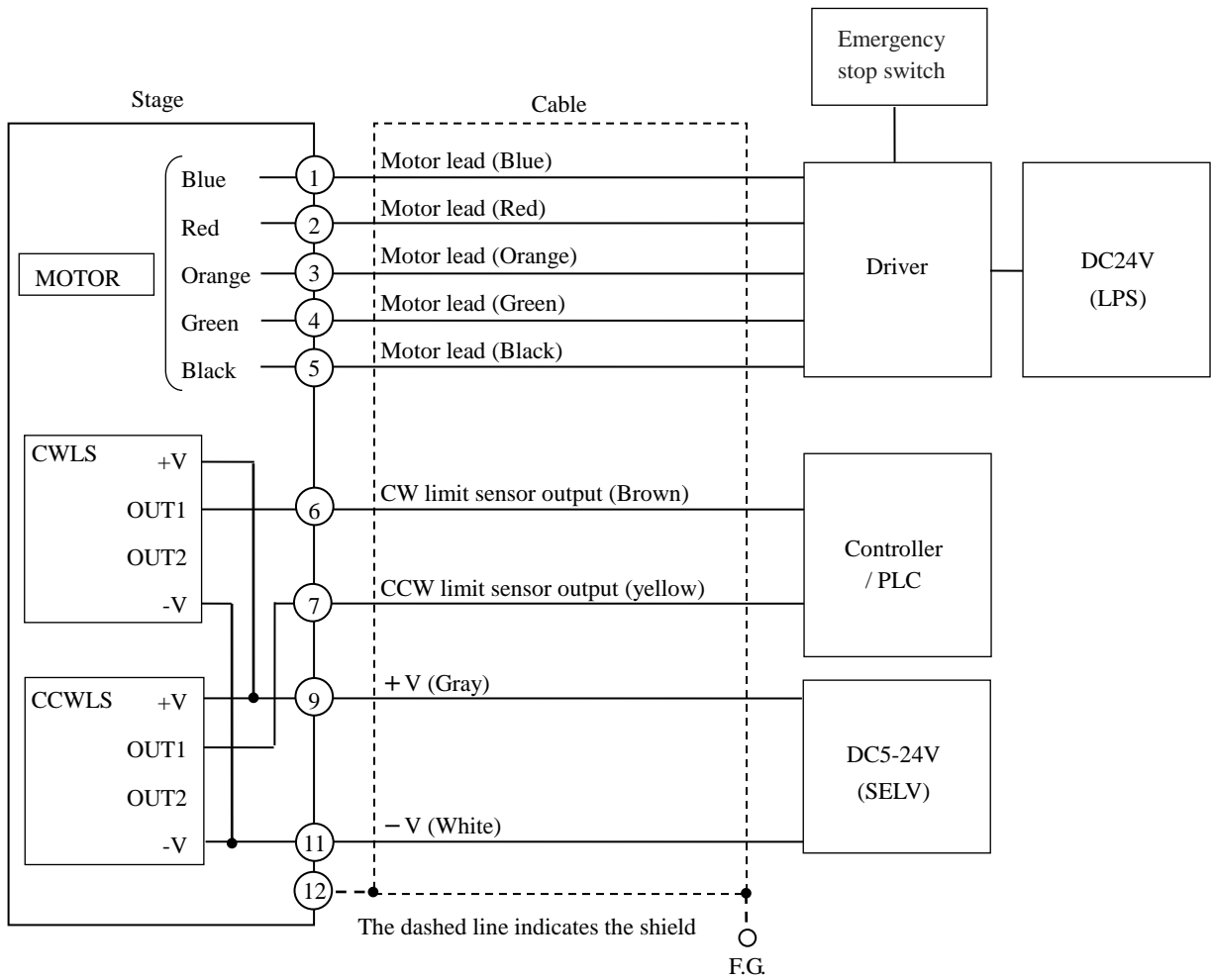

* Install an emergency stop switch on the power supply of the driver.

With sensor option

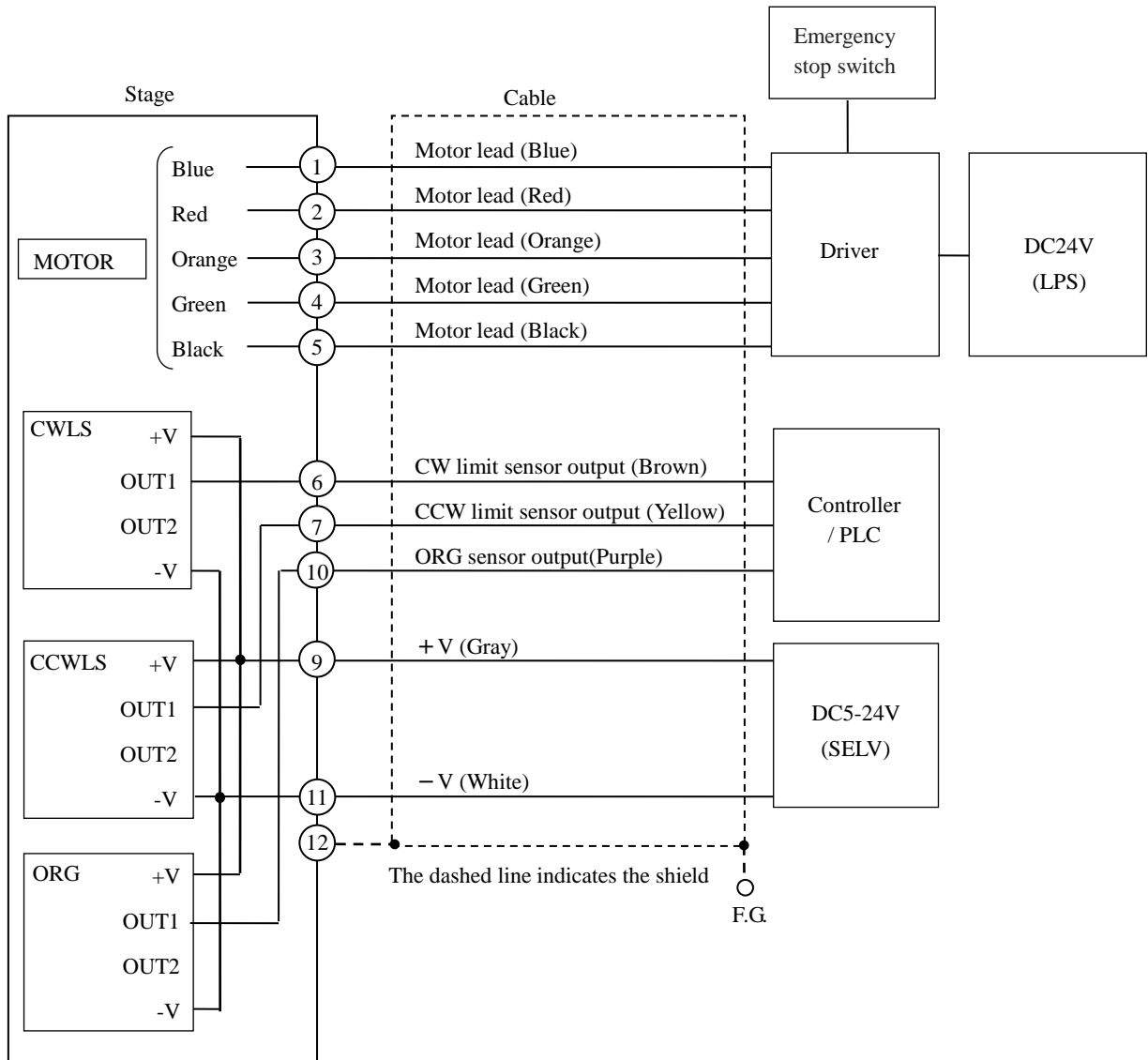

* Install an emergency stop switch on the power supply of the driver.



There is a possibility that hands may be trapped, potentially resulting in injury if abnormal operation occurs due to incorrect wiring.

Perform test operation to verify whether the product is functioning normally.

2.9 Operating Environment

Operating environment: Indoors, 5 to 50 °C, 20 to 70% RH (there should be no condensation)

Recommended operating environment: Indoors, 22 ± 5 °C, 20 to 70% RH (there should be no condensation)

Above sea level: 2000m or lower

Protection level: IP00 (IEC60529)

Overvoltage category: II

Pollution level: 2 (IEC60664-1)

The temperature at which the product can be used will differ due to the wide-ranging conditions involved such as stage installation conditions, operating conditions, and performance.



Avoid use in places such as the following. Failure to observe this may result in an accident or a fault.



- Places with a lot of dust or powder dust (especially metal powder)
- Places exposed to direct sunlight or radiant heat
- Places near fire
- Places where the product may be exposed to water or oil
- Places where corrosive gas or flammable gas are produced
- Places subject to vibration or shock
- Places with a lot of salt content or organic solvent
- Places where X-rays are in use

2.10 Mounting Guidelines

■ Equipment on which the table, base are mounted

Flatness guideline for applicable equipment: within 10 μm



Mounting equipment of poor flatness on the table or base, or mounting a table or base of poor flatness on equipment may result in deformation of the stage surface and affect accuracy.

■ Mounting orientation

The stage specifications are based on the condition that it is installed on a flat surface. Caution is required if using the product when installed on other than a flat surface such as when mounted vertically or horizontally on its side. Both withstand load and accuracy will be greatly affected by the mounting orientation. Please contact the SURUGA SEIKI marketing centre if there are points on which you are unclear.



Side face vertical mounting



The table may fall depending on the workpiece load when the power is turned OFF, and therefore a control method which ensures that the table stops at the down end when the power is turned OFF should be employed.

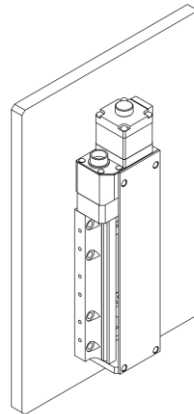

Carrying out mounting work with an unnatural posture may result in injury or damage if the product drops. Check the safety of the surrounding environment, and carry out mounting work with a safe posture.

■ **Mounting method**

Move the table by rotating the motor knob, and then secure it using all of the stage mounting knobs. Use the screws provided to mount the table, and tighten the screws with a tightening torque of 2.3 N·m.

KXL06030/050/075/100

Mounting screws: M4x14 hexagon socket head cap bolts: 8

KXL06150

Mounting screws: M4x14 hexagon socket head cap bolts: 14

KXL06200

Mounting screws: M4x14 hexagon socket head cap bolts: 12

KXL06300

Mounting screws: M4x14 hexagon socket head cap bolts: 16

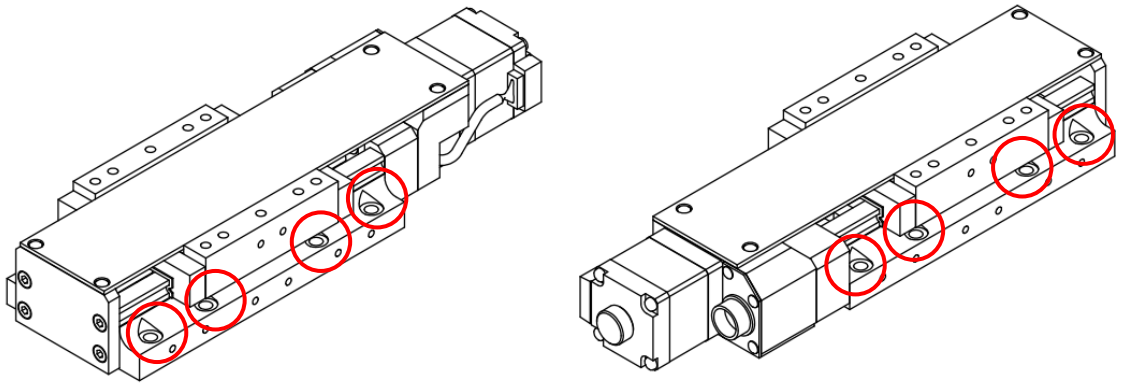

Red circles: mounting holes
(ex. KXL06030/050/075/100)

KZL06030/050/075

Mounting screws: M4x10 hexagon socket head cap bolts: 4

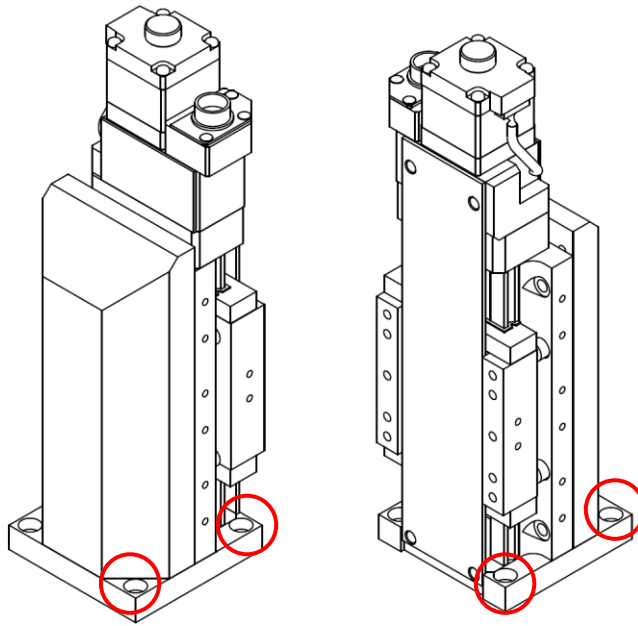

Red circles: mounting holes



When mounting the stage, ensure a sufficient work space to ensure that the prescribed tightening torque can be applied.

3. Compliance with EU Directives

3.1 Low Voltage Directive

EN 61010-1:2010

Safety requirements for electrical equipment for measurement, control, and laboratory use -
Part 1: General requirements

3.2 EMC Directive

SURUGA SEIKI conducts EMC testing on the stage based on "Example of installation and wiring" below.

Compliance with the EMC Directive will differ depending on the controller and wiring used with the product, as well as the product layout. To ensure EMC compliance, it is therefore necessary to install and wire the product based on "Example of installation and wiring" below, and customers are responsible for verifying EMC compliance for their own machines.

EN 61000-6-2:2005

Electromagnetic compatibility (EMC)

Generic standards

Immunity for industrial environments

EN 61000-6-3:2007+A1:2011

Electromagnetic compatibility (EMC)

Generic standards

Emission standard for residential, commercial and light-industrial environments

3.3 RoHS Directive

This product complies with the following RoHS Directive standard.

EN 50581: 2012

Technical documentation for the assessment of electrical and electronic products with respect to the restriction of hazardous substances

3.4 Compliance with EMC Directive

■ Example of installation and wiring

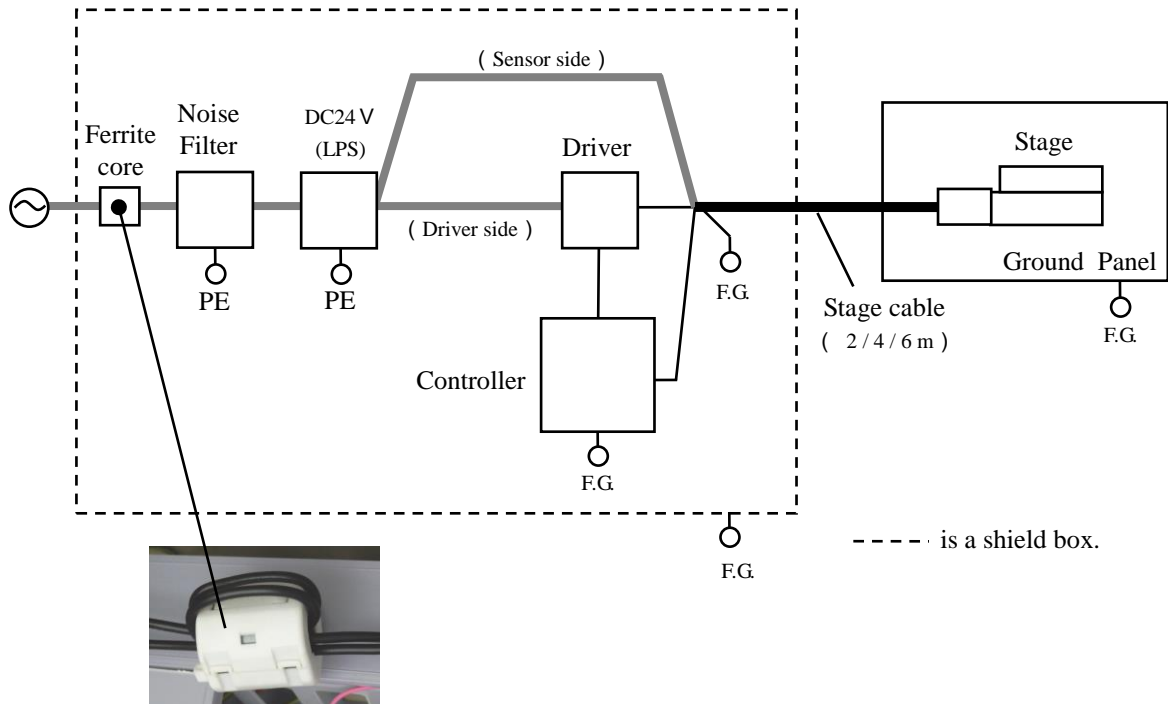

Ferrite core (KRFC-13, Kitagawa Industries Co., Ltd.)



Stage installation

Mount the stage on a grounded metal plate.



Controller, driver, DC power supply installation



- Use a controller and DC power supply which comply with the EMC Directive.
- Use a DC power supply with reinforced insulation at both the primary and secondary sides, and for which output is restricted (LPS).
- Use the driver specified by SURUGA SEIKI.(Specified driver: CVD507-K)
- Install the driver, controller, and DC power supply inside the housing.
- Install a noise filter at the DC power supply primary side (AC input side).
- Attach a ferrite core (KRFC-13, Kitagawa Industries Co., Ltd.) with two turns locate to immediate vicinity of the noise filter.
- Employ a configuration and arrangement that allows the supply of power to the DC power supply to be cut off in the event of an abnormality.



Cable connection

- Use a stage cable specified by SURUGA SEIKI.
(Specified stage cables: D214-2-2EK, D214-2-4EK, D214-2-6EK,
D214-2-2RK, D214-2-4RK, D214-2-6RK)



- Wire the cable with the shortest length of wiring, and do not wrap or bundle the excess portion if too long.



Grounding method

- Use a wide, thick, even grounding surface for the grounding point.

4. Maintenance and Inspection

4.1 Inspection

Inspect the following items before and after stage operation.

If an abnormality occurs, stop using the product, and contact SURUGA SEIKI Co., Ltd.

[Inspection items]

- Is there an abnormal noises?
- Is there an abnormal odour?
- Is the cable is damaged or torn?
- Are there any signs of liquids having been covered up, or any foreign material inside the stage?
- Are there any signs of dropping or external impact?
- Is there any mounting screw or connector connection looseness?
- Is there any play in component parts such as the table or cover?



When carrying out inspections, always cut the supply of power to the DC power supply to ensure safety. After doing so, disconnect the stage cable from the stage.



If any abnormalities are confirmed, cut the supply of power to the DC power supply immediately. After doing so, disconnect the stage cable from the stage.



Employ a configuration and arrangement that allows the supply of power to the DC power supply to be cut off.



Grease is used on this product. There is a possibility of inflammation if grease adheres to the body when carrying out cleaning or inspection, etc. If grease adheres to the body, wash thoroughly to remove.



Wear protective gloves when carrying out inspections.

4.2 Maintenance

If abnormalities are observed when carrying out inspections, contact SURUGA SEIKI Co., Ltd., and if a fault is then suspected, return the product to SURUGA SEIKI Co., Ltd. for repair.

Inquiries

Tel: +81-3-6711-5014
FAX: +81-3-6711-5021
URL: <http://eng.surugaseiki.com>
E-mail: e-ost@suruga-g.co.jp

SURUGA SEIKI Co., Ltd.
a MISUMI Group Company

- Head Office & Main Factory
505 Nanatsushinya, Shimizu-ku, Shizuoka-city, Shizuoka 424-8566 JAPAN
- Tokyo Branch Office
3F Konan YK Bldg., 2-4-12an, Minato-ku, Tokyo 108-0075 JAPAN



Disassembly or repairs carried out by the customer may result in injury. Never disassemble or repair the product.

4.3 Storage and Transport

■ Storage and transport environment

Storage and transport environment: -25 to 70 °C (there should be no freezing), 85% RH or lower (there should be no condensation)

Protection level: IP00

Pollution level: 2



Avoid storing the product in places such as the following.



- Places with a lot of dust or powder dust (especially metal powder)
- Places exposed to direct sunlight or radiant heat
- Places near fire
- Places where the product may be exposed to water or oil
- Places where corrosive gas or flammable gas are produced
- Places subject to vibration or shock
- Places with a lot of salt content or organic solvents
- Places where X-rays are in use



■ Storage precautions

- Disconnect the cable and store it in the SURUGA SEIKI packaging.
- Do not place anything on the packaging.



■ Transport precautions

- Do not drop or strike the product.
- Disconnect the cable, and carry the product by holding the base with both hands.
- When transporting the product in a manner in which vibrations are applied, do so in the SURUGA SEIKI packaging.

4.4 Disposal Method



When disposing of the product, do so in an appropriate manner using the disposal method specified in the laws and ordinances of each country.

5. **Warranty Scope, Warranty Period**

1. If product defects such as damage, deformation, or flaws attributable to SURUGA SEIKI are acknowledged, the product shall be replaced, either in part or in full, or the defect, etc. repaired free of charge provided that SURUGA SEIKI receives a satisfactory, detailed account of the defect, etc. within the warranty period (defined in next item), and SURUGA SEIKI acknowledges that they are responsible for the defect, etc.

However, defects, etc. applicable to the following items are not covered by the scope of this warranty.

 - (1) Defects, etc. arising from the use of this product in the medical equipment, pharmaceutical, biological, food, or cosmetic fields
 - (2) Defects, etc. arising from the use of this product for aerospace instruments, nuclear plant components, weapons, arms, or other military applications
 - (3) Defects, etc. arising from careless or incorrect handling by the customer
 - (4) Defects, etc. arising from natural disasters (includes, but not limited to earthquakes, fire, floods)
 - (5) Defects, etc. arising from use of the product that does not comply with the prohibited or compulsory items, standards, applications, or usage conditions, etc. highlighted by the danger, warning, and caution items indicated in this manual.
 - (6) Defects, etc. arising from unauthorized machining of, repairs to, modification of, or disassembly and so on of the product by the customer.
 - (7) Defects, etc. caused by other equipment.
 - (8) Defects, etc. arising from use with unfamiliar or unexpected purpose or method.
2. The warranty period applicable to this product as prescribed in these warranty provisions shall be one year from the date on which the product is delivered to the customer by SURUGA SEIKI.
3. This warranty does not apply to defects such as minor scratches, dirt, dents, or discolouration, etc. that do not render use of the product impossible. The warranty shall apply, however, if the relevant scratches, dirt, dents, or discolouration, etc. are acknowledged as being particularly prominent by SURUGA SEIKI.
4. The customer should inspect the product within one week of the day on which it is received to check the name, model, and quantity, whether the product matches the standards indicated in this catalogue, and whether there are any defects, etc., and if any defects, etc. are found, SURUGA SEIKI should be notified during the relevant period. If SURUGA SEIKI is not notified within the relevant period, it shall be deemed that any defects, etc. which should be subject to replacement or repair have passed the customer's inspection, and therefore caution is advised.

5. A fee shall be required for product replacement or repairs after the warranty period has expired, or for reasons which lie outside the applicable scope of these warranty provisions other than the scope of the warranty.

6. There may be cases in which repair or replacement is not possible depending on the product characteristics, date of manufacture, or standards.

■ **Contact Information**

Tel: +81-3-6711-5014

FAX: +81-3-6711-5021

URL: <http://eng.surugaseiki.com>

E-mail: e-ost@suruga-g.co.jp

SURUGA SEIKI Co., Ltd.

a MISUMI Group Company

■ **Head Office & Main Factory**

505 Nanatsushinya, Shimizu-ku, Shizuoka-city, Shizuoka 424-8566 JAPAN

■ **Tokyo Branch Office**

3F Konan YK Bldg., 2-4-12 Konan, Minato-ku, Tokyo 108-0075 JAPAN

PGF17-0009-001